



## Dental reality

There's only one thing closer to reality than frasaco's phantom heads, jaw and teeth models and strip crowns, and that's the real thing itself



# contents

## dental models

Standard working model series ANA-4	4 – 16
Standard working model series AG-3	17 - 26
Standard working model series A-3	27 - 31
Preparation training	33
Endodontic exercises	34 - 41
Implantology	42 - 48
Edentulous models and dental laboratory	49 - 50
Dental hygiene and periodontology	51 - 55
X-ray, local anaesthesia and extractions	56 - 58
Oral surgery	59 - 60
Pediatric dentistry	62 - 66
Orthodontics	67
Demonstration models	68 - 69

## phantom heads

Characteristics of our phantom heads	72
frasaco phantom heads P-6/3 and P-6/5	73 - 74
Accessories for frasaco phantom heads	75 - 76
frasaco phantom heads PK-1 and PK-2	77 - 78
Complete sets	79 - 82
Mounting assemblies	83 - 89
Dental training systems	90 - 91

## sundries

Strip crowns	93 - 97
Pedodontal strip crowns	98
Matrix strips and dispensers	99

<b>Certificates</b>	100 – 101
---------------------	-----------

<b>General commercial conditions</b>	102 – 103
--------------------------------------	-----------





## dental models

### working and demonstration models

frasaco offers the most comprehensive range of dental simulators, study models and training models for hands-on practice:

in pre-clinical and post-graduate students' laboratories in preventive and operative dentistry as well as fixed, removable and full prosthodontics, pediatric dentistry and orthodontics, radiology and anesthesia, endodontics, exodontia and oral surgery, oral hygiene, periodontology, gerodontology and implantology, pathology, anatomy and dental technique.

### Videos:



On the following pages, we introduce our dental models. Practice the reality with frasaco dental models and watch our application videos.

[www.frasaco.de/video](http://www.frasaco.de/video)

# standard working model series ANA-4

Dental model representing typical natural adult dentition:

Model base made from a hard thermosetting plastic material. Upper and lower jaws occlude in a definite central occlusion with natural physiological contact points. 28 model teeth made of hard thermosetting plastic material are securely positioned in the model with Philips head screws. ANA-4 dental models include a threaded metal back plate for screw retention or optional retention with a magnetic mounting plate in frasaco phantom heads.

- Anatomical crown and occlusal contours based on the function and morphology of natural teeth
- Natural occlusal contour based on a representative cross section of different distinctive contour characteristics
- Anterior tooth contours are aesthetic and functional
- Natural anatomical cervical root contour
- Neutral intercuspitation according to the international classification of Angle Class I
- Physiological interproximal space contoured according to the average dentition of a middle-aged adult
- Wilson, Spee and helicoid curves 3 dimensionally reproduced
- Option of performing different dynamic occlusion concepts like canine guidance or unilateral group function
- Replica gingiva with natural palatal folds, buccal and lingual anatomical simulation

Gingiva:

elastic, removable gingiva

Main use:

Universal model for realistic exercises in preventive, conservative and prosthetic dentistry



**ANA-4** upper and lower model jaws in a stable intercuspitation (28 teeth)

**ANKA-4** same upper and lower model jaws in a stable intercuspitation as ANA-4, model teeth however not fixed with screws, but with the frasaco click system (28 click-in teeth)



**ANA-4 V** upper and lower model jaws in a stable intercuspitation like ANA-4 (28 teeth), however contours of the gingivae are simplified for easier preparations. This style is used by most universities for preparation training, while ANA-4 is mainly used in postgraduate education

**ANKA-4 V** like ANA-4 V, model teeth however not fixed with screws, but with the frasaco click system (28 click-in teeth)



**ANA-4 DAV** upper and lower model jaws with a demonstration articulator of unique design allowing simple functional movements (assembled to the model base with a dovetail joint).

**ANA-4 V DAV** like ANA-4 DAV, however with simplified gingival contours

**ANKA-4 DAV** upper and lower model jaws combined with an adjustable demonstration articulator like ANA-4 DAV, model teeth however not fixed with screws, but with the frasaco click system (28 click-in teeth)

**ANKA-4 V DAV** like ANKA-4 DAV, however with simplified gingival contours

# ANA-4 dental models and accessories

- ANA-4 DAF** upper and lower model jaws combined with a demonstration articulator allowing simple functional movements (articulator fixed with screws to the model base).
- ANA-4 V DAF** like ANA-4 DAF, however with simplified gingival contours
- ANKA-4 DAF** upper and lower model jaws like ANA-4 DAF combined with a demonstration articulator, model teeth however not fixed with screws, but with the frasaco click system
- ANKA-4 V DAF** like ANKA-4 DAF, however with simplified gingival countours
- AN-4 WOK** elastic replacement gingiva for upper jaw, positioned over the model base, held in place by the model teeth, suitable for ANA-4 OK or ANKA-4 OK
- AN-4 WOK KR** as above, however in red-transparent execution
- AN-4 WOKV** as above, however in simplified execution suitable for ANA-4 V OK or ANKA-4 V OK
- AN-4 WUK** elastic replacement gingiva for lower jaw, positioned over the model base, held in place by the model teeth, suitable for ANA-4 UK or ANKA-4 UK
- AN-4 WUK KR** as above, however in red-transparent execution
- AN-4 WUKV** as above, however in simplified execution suitable for ANA-4 V UK or ANKA-4 V UK
- AN-4 WOKV 99-001** hard plastic replacement gingiva with simplified contours suitable for ANA-4 V OK or ANKA-4 V OK
- AN-4 WUKV 99-001** hard plastic replacement gingiva with simplified contours suitable for ANA-4 V UK or ANKA-4 V UK
- AN-4 RM** spare part: threaded metal plate for dental models series ANA-4 (V), ANKA-4 (V), AG-3, A-PB and A-PZ for screw-in or magnetic fixation in frasaco phantom heads
- AN-4 ROK** spare part: back plate for upper jaws of series ANA-4 (V) and ANKA-4 (V)
- AN-4 RUK** spare part: back plate for lower jaws of series ANA-4 (V) and ANKA-4 (V)

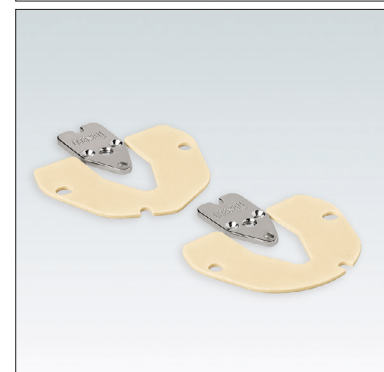
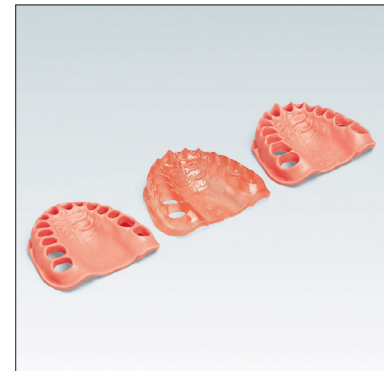
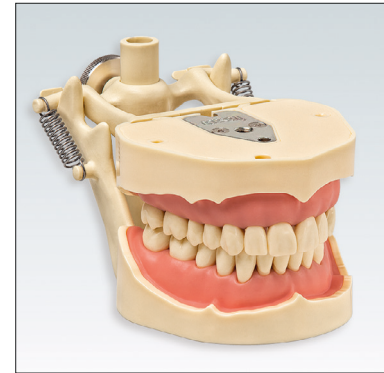

# ANA-4 accessories

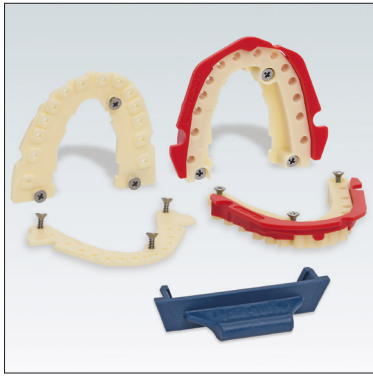

## AN-4 KPS

set of click-in plates with locking mechanism for changing over existing ANA-4 (V) models to the frasaco click system

## WZ-1

frasaco ANKA-4 (V) models do include this tool which is needed to open the locking plate AN-4 KPS

## AN-4 SPS

set of mounting plates for changing over existing models with frasaco click system to the traditional screw retention system e.g. for exam situations



## AN-4 SPE OK 001

mounting plate with screws for changing existing upper models of the ANA-4 (V) series to the new frasaco endo-teeth with whole root, as shown on pages 11 to 13 and 37, to allow fixing at positions 21, 24 and 26

## AN-4 SPE UK 001

mounting plate with screws for changing existing lower models of the ANA-4 (V) series to the new frasaco endo-teeth with whole root, as shown on pages 11 to 13 and 37, to allow fixing at position 46



## AN-4 SPE OK 003

mounting plate with screws for changing existing upper models of the ANA-4 (V) series to the new frasaco endo-teeth with whole root, as shown on pages 11 to 13 and 37, to allow fixing at positions 11, 16, 21, 24 and 26

## AN-4 SPE UK 003

mounting plate with screws for changing existing lower models of the ANA-4 (V) series to the new frasaco endo-teeth with whole root, as shown on pages 11 to 13 and 37, to allow fixing at positions 36, 45 and 46

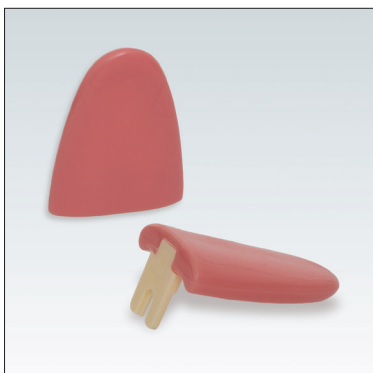

## P-Z

removable elastic tongue

The tongue is fixed to the model with a screw. To retrofit existing models, the tongue must be adhered to the model. We recommend the adhesive A-P K G.



## SZ-4

screwdriver for Philips head screws as used in frasaco models series ANA-4 (V) and for all frasaco models with multi-head screws

## SZ-4 K

SZ-4 K screwdrivers are supplied with a cover to use when pushing the model teeth out of model bases equipped with the click-in system

# ANA-4 standard teeth and special teeth

- ANA-4 Z** set of 28 model teeth in natural design with screws, execution in hard thermosetting plastic material to fit ANA-4 (V) models
- ANA-4 ZE 010** bag containing 10 individual model teeth of the same position to fit ANA-4 (V) models, with screws
- ANA-4 ZE 100** bag containing 100 individual model teeth of the same position to fit ANA-4 (V) models, with screws
- ANKA-4 Z** set of 28 model teeth in natural design, execution in hard thermosetting plastic material to fit the frasaco click system models ANKA-4 (V)
- ANKA-4 ZE 010** bag containing 10 individual model teeth of the same position to fit the frasaco click system models ANKA-4 (V)
- ANKA-4 ZE 100** bag containing 100 individual model teeth of the same position to fit the frasaco click system models ANKA-4 (V)
- ANA-4 V CER** upper and lower model jaws type ANA-4 V as shown on page 4, however with teeth made of a special thermosetting material which does allow working with scanners or camera systems without having to use contrast powder or sprays. Especially recommended for Sirona prepCheck and CEREC\* with Bluecam  
\*CEREC® is a registered trade mark of Dentsply Sirona
- ANKA-4 V CER** upper and lower model jaws like ANA-4 V CER, model teeth however not fixed with screws, but with the frasaco click system
- ANA-4 Z CER** set of 28 model teeth in natural design with screws, execution in special thermosetting plastic material to fit ANA-4 V CER models
- ANA-4 ZE CER 010** bag containing 10 individual model teeth in natural design with screws, execution in special thermosetting plastic material to fit ANA-4 V CER models
- ANA-4 ZE CER 100** bag containing 100 individual model teeth in natural design with screws, execution in special thermosetting plastic material to fit ANA-4 V CER models
- sets of model teeth and bags of individual model teeth are also available for ANKA-4 V CER
- ANA-4 ZEF** For examinations:  
 model teeth made of fluorescent material with screws, optional assortment. These patent protected exam teeth can easily be distinguished from standard model teeth while staying fixed in the jaw model by means of an ultraviolet-lamp. Exclusively delivered directly to the institutional examination committees
- ANKA-4 ZEF** like ANA-4 ZEF, however fitting the frasaco click system models
- UV-L** ultraviolet-testing lamp for easy identification of ANA-4 ZEF or ANKA-4 ZEF exam teeth

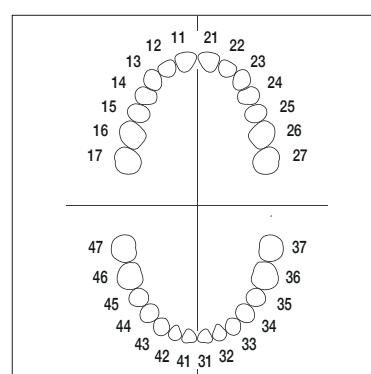
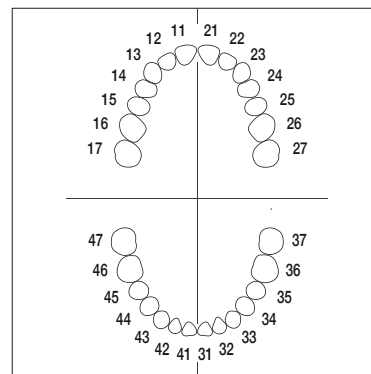



# ANA-4 preparations and special teeth



## **ANA-4 ZP..**

for ANA-4 (V) models frasco can offer teeth with special preparations according to customers' specification. Please let us know the quantities required and provide a master preparation cut on an ANA-4 ZE standard tooth. Pictures of all currently available teeth with preparations will be supplied upon request

## **ANKA-4 ZP..**

like ANA-4 ZP, however fitting the frasco click system models



## **ANA-4 ZP.. GE**

all model teeth with preparations can also be supplied in yellow instead of a tooth shade. This allows templates of optimum preparations to be easily distinguished from the work results of students. Composite restorations can also be clearly demarcated from the tooth structure for training purposes

## **ANKA-4 ZP.. GE**

like ANA-4 ZP.. GE, however fitting the frasco click system models



## **ANA-4 ZP..**

the 4 upper anterior preparations ANA-4 ZP12 99-020, ANA-4 ZP11 99-020, ANA-4 ZP21 99-020 and ANA-4 ZP 22 99-020 for treatment with veneers should be highlighted among the large number of preparations provided. This way identical preparation situations can be made available for all course participants

## **ANKA-4 ZP..**

like the 4 upper anterior preparations outlined above, the articles ANKA-4 ZP12 99-020, ANKA-4 ZP11 99-020, ANKA-4 ZP21 99-020 and ANKA-4 ZP22 99-020 are offered fitting the frasco click system models



## **ANA-4 ZP..**

diastema: the two model teeth ANA-4 ZP11 99-010 and ANA-4 ZP21 99-002 together represent a diastema situation

dental trauma: the fractured teeth ANA-4 ZP11 99-012 and ANA-4 ZP21 99-008 can be treated with the aid of a frasco strip crown size 111 and 211

## **ANKA-4 ZP..**

like the upper anterior preparations outlined above, the special teeth ANKA-4 ZP11 99-010, ANKA-4 ZP21 99-002, ANKA-4 ZP11 99-012 and ANKA-4 ZP21 99-008 are offered fitting the frasco click system models



## **ANA-4 TUKV 201 99-001**

a partially edentulous lower model from the ANA-4 TUKV 201 series (see page 15) has been used as a base with this model. A standard implant analogue (hexagonal) has been inserted in the alveolus in the edentulous region 36. This already allows implant prosthetic exercises at the preclinical level at little cost. Other partial dentitions can be used if desired and implant analogues can be fitted in other positions.

## **ANA-4 WSJ36**

bone segment to fit in position 36, in which an implant analogue has been fitted. Due to the type of design these bone segments cannot be used for our models with click retention in the ANKA-4 (V) series

# ANA-4 special teeth

**ANA-4 AE OK** Erosion model consisting of an ANA-4 OK series upper jaw, however, the screwed model teeth of positions 11 to 15 and 21 to 25 show strong erosions and abrasions. Positions 16 and 17 or 26 and 27 are standard ANA-4 ZE model teeth. Thus, the model series ANA-4 is extended for another use. Combinations with standard lower jaws of the same series or variants are possible on request



**ANA-4 ZAE.. 901** model tooth with abrasions and erosions, as used in ANA-4 AE OK and therefore only available for positions 11-15 and 21-25



**ANA-4 AW** upper and lower model bases and removable gingivae corresponding to ANA-4. Instead of model teeth, only tooth preparations for waxing exercises are mounted. A complete model tooth can be sculpted on each tooth preparation

standard models ANA-4 V and ANKA-4 (V) are also available with tooth preparations on request



**ANA-4 AW Z 901** complete set with 28 model tooth preparations for waxing up exercises, includes screw

**ANA-4 ZAW.. 901** individual model tooth preparation for waxing up exercises, includes screw, optional assortment

The tooth preparations are also available for the click models in the ANKA-4 (V) series on request

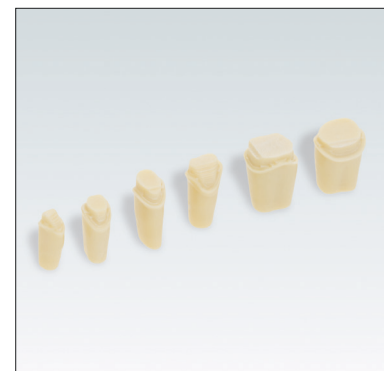

**ANA-4 ZP46 99-029** model tooth prepared for an onlay to fit ANA-4 (V) models

**ANKA-4 ZP46 99-029** model tooth prepared for an onlay to fit ANKA-4 (V) models

**ANA-4 OL46 99-029** onlay exactly fitting to above mentioned teeth made of frasco plastic material



# ANA-4 special teeth



**ANA-4 ZSD.. 300** new version of frasco 2-layer posterior teeth, enamel made of new frasco adamant-material with noticeable difference in hardness between enamel and dentine during preparation

upper	24, 25, 26, 27
lower	46

**ANKA-4 ZSD.. 300** like ANA-4 ZSD.. 300, however fitting the frasco click system models



**ANA-4 ZSD.. 300** new version of frasco 2-layer anterior teeth, enamel made of new , frasco translucent adamant-material (suitable for aesthetic dentistry) with noticeable difference in hardness between enamel and dentine during preparation

upper	11, 12, 13, 21, 22, 23,
-------	-------------------------

**ANKA-4 ZSD.. 300** like ANA-4 ZSD.. 300, however fitting the frasco click system models



**ANA-4 ZSDP.. 300** new version of frasco 3-layer teeth simulating enamel, dentine and pulp made of new frasco adamant-material with noticeable difference in hardness between enamel and dentine during preparation, red pulp tissue-like. Red pulp shining through if approached too closely during preparation

upper	21, 24, 26
lower	46

**ANKA-4 ZSDP.. 300** like ANA-4 ZSD.. 300, however fitting the frasco click system models

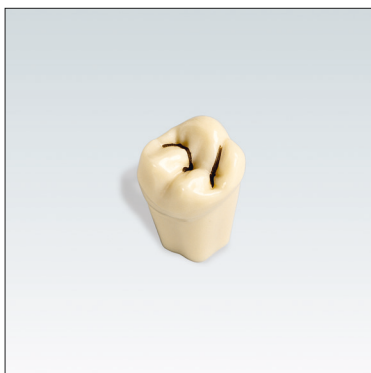

**ANA-4 ZFK17** upper 17 model tooth series ANA-4 ZE with pit and fissures caries. Please let us have your inquiry for custom made pit and fissure caries positions

**ANKA-4 ZFK17** like ANA-4 ZFK17, however fitting the frasco click system models



**ANA-4 ZK.. V1** Matching model ANA-4 (V) we can offer model teeth with undermining caries, which can be recognized in the new, soft version 1 with dental X-ray and treated realistically. This program is constantly being expanded. Please request a list of the currently available variants. In addition, we also manufacture model teeth according to customer specifications. Please tell us your exact requirements and send us an ANA-4 ZE model tooth prepared according to your ideas as a sample

**ANKA-4 ZK..V1** like ANA-4 ZK..V1, however fitting the frasco click system models



# ANA-4 special teeth

**ANA-4 ZSDK.. 300 V1** like ANA-4 ZSD.. 300 (enamel-dentine), but with undermining caries version 1; available for upper 21 approximal, upper 24 mesial and distal, upper 26 occlusal and lower 46 occlusal and mesial

**ANKA-4 ZSDK.. 300 V1** like ANA-4 ZSDK.. 300 V1, however fitting the frasco click system models

This program is constantly being expanded. Please request a list of the currently available variants. In addition, we also manufacture model teeth according to customer specifications. Please tell us your exact requirements

**ANA-4 ZSDPK.. 300 V1** like ANA-4 ZSDP.. 300 (enamel-dentine-pulp), but with undermining caries version 1; available for upper 21 approximal, upper 24 mesial and distal, upper 26 occlusal and lower 46 occlusal und mesial

**ANKA-4 ZSDPK.. 300 V1** like ANA-4 ZSDK.. 300 V1, however fitting the frasco click system models

This program is constantly being expanded. Please request a list of the currently available variants. In addition, we also manufacture model teeth according to customer specifications. Please tell us your exact requirements

**ANA-4 ZPUK** model teeth with root canals, fitting ANA-4 (V) models, execution in transparent plastic material with red pulpal walls and ivory crowns in hard thermosetting material  
upper 21, 24, 26  
lower 46

**ANKA-4 ZPUK** model teeth with root canals as above, however fitting the frasco click system models ANKA-4 (V)  
upper 21, 24, 26  
lower 46

**ANA-4 ZPUR** model teeth with root canals fitting ANA-4 (V) models, ivory crowns and roots with red pulpal walls for pre-clinical training in root canal treatment, suitable for x-ray control  
upper 21, 24, 26  
lower 46

**ANKA-4 ZPUR** model teeth with root canals as above, however fitting the frasco click system models ANKA-4 (V)  
upper 21, 24, 26  
lower 46

**ANA-4 ZPUKN 11** training tooth upper 11 with anatomical root, which can be used for simulating all steps of root canal treatment; fits into the locking mechanism of AN-4 SPE upper 003. A crown part made of the proven frasco tooth material gives a realistic feeling during trepanation exercises. The red shaded root canal in the transparent root part can be prepared and filled in the same way as a natural tooth

**ANA-4 ZPUKN TM 11** TM version of the aforementioned tooth is prepared according to the principles of minimally invasive technique.

**ANA-4 ZPUKN TT 11** TT version of the aforementioned tooth is prepared according to the traditional principles

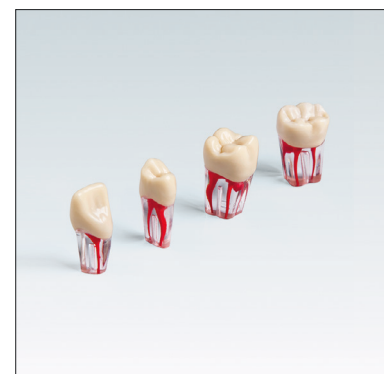

# ANA-4 special teeth



**ANA-4 ZPUKN 16** Training tooth upper 16 with anatomical roots, which can be used for simulating all steps of root canal treatment, fixed with screw into AN-4 SPE OK 003. A crown part made of the proven frasco tooth material gives a realistic feeling during trepanation exercises. The red shaded root canals in the transparent root part can be prepared and filled in the same way as a natural tooth.

**ANA-4 ZPUKN TM 16** TM version of the aforementioned tooth is prepared according to the principles of minimally invasive technique.

**ANA-4 ZPUKN TT 16** TT version of the aforementioned tooth is prepared according to the traditional principles.



**ANA-4 ZPUKN 21** Training tooth upper 21 with anatomical root, which can be used for simulating all steps of root canal treatment, fits into the locking mechanism of AN-4 SPE OK 001 or 003. A crown part made of the proven frasco tooth material gives a realistic feeling during trepanation exercises. The red shaded root canal in the transparent root part can be prepared and filled in the same way as a natural tooth.

**ANA-4 ZPUKN TM 21** TM version of the aforementioned tooth is prepared according to the principles of minimally invasive technique.

**ANA-4 ZPUKN TT 21** TT version of the aforementioned tooth is prepared according to the traditional principles.



**ANA-4 ZPUKN 24** Training tooth upper 24 with anatomical roots, which can be used for simulating all steps of root canal treatment, fixed with screw into AN-4 SPE OK 001 or 003. A crown part made of the proven frasco tooth material gives a realistic feeling during trepanation exercises. The red shaded root canals in the transparent root part can be prepared and filled in the same way as a natural tooth.

**ANA-4 ZPUKN TM 24** TM version of the aforementioned tooth is prepared according to the principles of minimally invasive technique.

**ANA-4 ZPUKN TT 24** TT version of the aforementioned tooth is prepared according to the traditional principles.



**ANA-4 ZPUKN 26** Training tooth upper 26 with anatomical roots, which can be used for simulating all steps of root canal treatment, fixed with screw into AN-4 SPE OK 001 or 003. A crown part made of the proven frasco tooth material gives a realistic feeling during trepanation exercises. The red shaded root canals in the transparent root part can be prepared and filled in the same way as a natural tooth.

**ANA-4 ZPUKN TM 26** TM version of the aforementioned tooth is prepared according to the principles of minimally invasive technique.

**ANA-4 ZPUKN TT 26** TT version of the aforementioned tooth is prepared according to the traditional principles.



**ANA-4 ZPUKN 36** Training tooth lower 36 with anatomical roots, which can be used for simulating all steps of root canal treatment, fixed with screw into AN-4 SPE UK 003. A crown part made of the proven frasco tooth material gives a realistic feeling during trepanation exercises. The red shaded root canals in the transparent root part can be prepared and filled in the same way as a natural tooth.

**ANA-4 ZPUKN TM 36** TM version of the aforementioned tooth is prepared according to the principles of minimally invasive technique.

**ANA-4 ZPUKN TT 36** TT version of the aforementioned tooth is prepared according to the traditional principles.

# ANA-4 special teeth

**ANA-4 ZPUKN 45** Training tooth lower 45 with anatomical roots, which can be used for simulating all steps of root canal treatment, fixed with screw into AN-4 SPE UK 003. A crown part made of the proven frasaco tooth material gives a realistic feeling during trepanation exercises. The red shaded root canals in the transparent root part can be prepared and filled in the same way as a natural tooth.

**ANA-4 ZPUKN TM 45** TM version of the aforementioned tooth is prepared according to the principles of minimally invasive technique.

**ANA-4 ZPUKN TT 45** TT version of the aforementioned tooth is prepared according to the traditional principles.

**ANA-4 ZPUKN 46** Training tooth lower 46 with anatomical roots, which can be used for simulating all steps of root canal treatment, fixed with screw into AN-4 SPE UK 001 or 003. A crown part made of the proven frasaco tooth material gives a realistic feeling during trepanation exercises. The red shaded root canals in the transparent root part can be prepared and filled in the same way as a natural tooth.

**ANA-4 ZPUKN TM 46** TM version of the aforementioned tooth is prepared according to the principles of minimally invasive technique.

**ANA-4 ZPUKN TT 46** TT version of the aforementioned tooth is prepared according to the traditional principles.

**ANA-4 ZPURN** On pages 39 to 40 you will find further variants of endodontic teeth with anatomical roots, which can also be attached to model bases of the ANA-4 series using the screw plate sets shown on page 6. The program of radiolucent model teeth of type ANA-4 ZPURN is shown here as an example.

upper 11, 16, 21, 24, 26  
lower 36, 45, 46

Our endodontic program is characterized by continuous product improvements and program additions. Please ask us for the current list of available options.

**ANA-4 ZEE** model teeth fitting ANA-4 (V) models, with screws, simulating the situation after root canal treatment, holes are sealed with gutta-percha. Suitable for training the making of direct and indirect posts with plastic or non-plastic (metallic) materials

upper 14, 21, 24, 26  
lower 34

**ANKA-4 ZEE** model teeth with root canals as above, however fitting the frasaco click system models ANKA-4 (V)

upper 14, 21, 24, 26  
lower 34



# ANA-4 partially dentate upper model jaws



partially dentate upper model jaw, execution in hard thermosetting plastic material, elastic removable gingiva corresponding to ANA-4 V (corresponding to ANA-4 upon request)  
model teeth are securely fastened in the model with Philips head screws

partially dentate upper model jaws ANKA-4 TOKV are accordingly available with model teeth fixed with the frasaco click system

the following models are available ex stock:

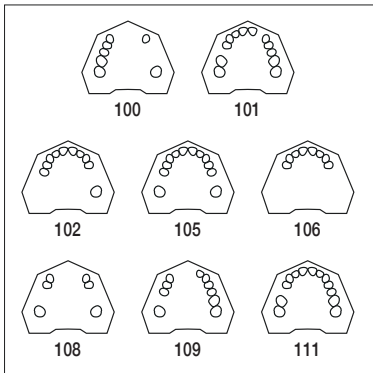

<b>ANA-4 TOKV 100</b>	7 6 5 4 3		3	7
<b>ANA-4 TOKV 101</b>	7 6	4 3 2 1		1 3 4 5 6 7
<b>ANA-4 TOKV 102</b>		5 4 3 2 1		1 2 3 4 7
<b>ANA-4 TOKV 105</b>	7	5 4 3 2 1		1 2 3 4 5 7
<b>ANA-4 TOKV 106</b>		4 3 2 1		1 2 3 4
<b>ANA-4 TOKV 108</b>	7	4 3		3 4 7
<b>ANA-4 TOKV 109</b>	7	5 4 3		2 3 4 5 6 7
<b>ANA-4 TOKV 111</b>	7 6	4 3 2 1		1 2 3 4 5 6 7



elastic removable gingiva for partially dentate upper model jaws, suitable for ANA-4 TOKV

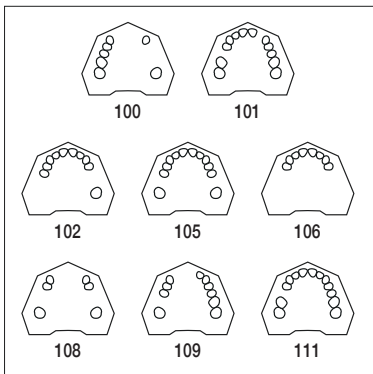

<b>AN-4 TWOKV 100</b>	7 6 5 4 3		3	7
<b>AN-4 TWOKV 101</b>	7 6	4 3 2 1		1 3 4 5 6 7
<b>AN-4 TWOKV 102</b>		5 4 3 2 1		1 2 3 4 7
<b>AN-4 TWOKV 105</b>	7	5 4 3 2 1		1 2 3 4 5 7
<b>AN-4 TWOKV 106</b>		4 3 2 1		1 2 3 4
<b>AN-4 TWOKV 108</b>	7	4 3		3 4 7
<b>AN-4 TWOKV 109</b>	7	5 4 3		2 3 4 5 6 7
<b>AN-4 TWOKV 111</b>	7 6	4 3 2 1		1 2 3 4 5 6 7

# ANA-4 partially dentate lower model jaws

partially dentate lower model jaw, execution in hard thermosetting plastic material, elastic removable gingiva corresponding to ANA-4 V (corresponding to ANA-4 upon request)  
model teeth are securely fastened in the model with Philips head screws

partially dentate lower model jaws ANKA-4 TUKV are accordingly available with model teeth fixed with the frasaco click system

the following models are available ex stock:

<b>ANA-4 TUKV 201</b>	7 6 5 4 3 2 1		1 2 3 4 5 7
<b>ANA-4 TUKV 207</b>	5 4 3		3 4 5 7
<b>ANA-4 TUKV 218</b>	3		3
<b>ANA-4 TUKV 231</b>	5 4 3 2 1		1 2 3 4 5
<b>ANA-4 TUKV 232</b>	3 2 1		1 2 3 4 7
<b>ANA-4 TUKV 234</b>	7 6 5 4 3 2 1		1 2 3 4 6 7
<b>ANA-4 TUKV 235</b>	7		3 2 1 1 2 3 4
<b>ANA-4 TUKV 236</b>	7 5 4 3 2 1		1 2 3 4 5 6 7
<b>ANA-4 TUKV 238</b>	7 5 4 3 2 1		1 2 3 4

elastic removable gingiva for partially dentate lower model jaws, suitable for ANA-4 TUKV

<b>AN-4 TWUKV 201</b>	7 6 5 4 3 2 1		1 2 3 4 5 7
<b>AN-4 TWUKV 207</b>	5 4 3		3 4 5 7
<b>AN-4 TWUKV 218</b>	3		3
<b>AN-4 TWUKV 231</b>	5 4 3 2 1		1 2 3 4 5
<b>AN-4 TWUKV 232</b>	3 2 1		1 2 3 4 7
<b>AN-4 TWUKV 234</b>	7 6 5 4 3 2 1		1 2 3 4 6 7
<b>AN-4 TWUKV 235</b>	7		3 2 1 1 2 3 4
<b>AN-4 TWUKV 236</b>	7 5 4 3 2 1		1 2 3 4 5 6 7
<b>AN-4 TWUKV 238</b>	7 5 4 3 2 1		1 2 3 4

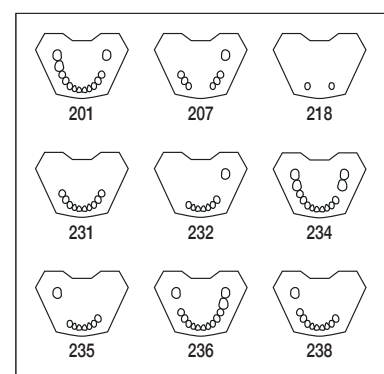
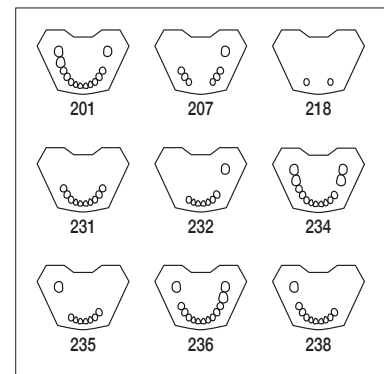

# ANA-4 rubber moulds



## **ANA-4 G**

rubber moulds for casting plaster study models, suitable for ANA-4 series. Partially dentate models can be created by blocking out segments



## **ANA-4 V G**

rubber moulds for casting plaster study models, suitable for ANA-4 V series

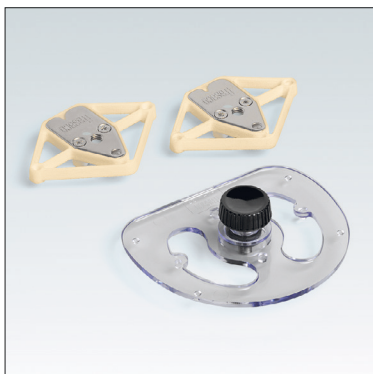

## **ANA-4 ZP**

transparent centric plate to be placed upon rubber moulds ANA-4 G and ANA-4 V G with four guidance pins, fixing screw and fixing plate with M6 mounting thread. Models cast from rubber moulds can be mounted in frasaco phantom heads or articulators with screw-in or magnetic fixation  
(Package containing: 1 centric plate, 1 fixing screw, 5 fixing plates)

## **AN-4 ZPE**

re-fill pack containing 10 fixing plates



# AG-3 standard working model series

Dental model representing typical natural adult dentition:

Model base made from a hard thermosetting plastic material. Upper and lower jaws are occluding in a stable intercuspitation with natural 32 screw-in model teeth made of hard thermosetting plastic material. A threaded metal back plate allows screw fixation or optional fixation with magnetic mounting plates in frasaco phantom heads.

Occlusal anatomy corresponding to an adolescent patient free of any abrasion (15 to 20 years old)

Intercuspitation:

- Anterior relationship: deep overbite, initial anterior and canine guidance
- Premolar to first molar region: tooth relationship = 1 : 2
- Second and third molar region: tooth relationship = 1 : 1 distally

Gingiva:

Elastic, removable gingiva based on the anatomy of a 40-year-old patient.

Main use:

Exercises in preventive and conservative dentistry and prosthodontia emphasizing functional occlusion.

For hygiene training please see our model AG-3 H on page 51.

**AG-3** upper and lower model jaws in a stable intercuspitation (32 teeth)



**AG-3 28** upper and lower model jaws in a stable intercuspitation (28 teeth)  
Replacement gingivae can be ordered on pages 24 and 25 listed as AG-3 TWOK 103 and AG-3 TWUK 228



**AG-3 W 20** this model is similar to the AG-3 however the gingival contour is taller to represent that of a 20-year-old patient.



# AG-3 accessories

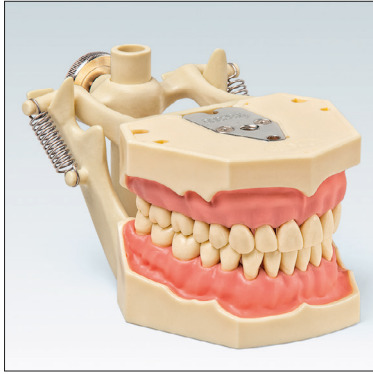

**AG-3 DA**

upper and lower model jaws combined in a demonstration articulator allowing simple functional movements



**AG-3 WOK**

elastic removable gingiva for upper jaw, positioned over the model base, held in place by the model teeth suitable for AG-3 OK



**AG-3 WUK**

elastic removable gingiva for lower jaw, positioned over the model base, held in place by the model teeth suitable for AG-3 UK



**AG-3 WOK 20**

elastic removable gingiva for upper jaw, similar to AG-3 WOK, however the gingival contour is taller to represent that of a 20-year-old patient

**AG-3 WUK 20**

elastic removable gingiva for lower jaw, similar to AG-3 WUK, however the gingival contour is taller to represent that of a 20-year-old patient



**AG-3 WOKH**

By changing the gingivae, AG-3 models can be transformed into AG-3 H dental hygiene models as shown on page 51. Further accessories can be found there.

elastic removable gingiva for oral hygiene model upper jaw, held in place by the model teeth

**AG-3 WUKH**

elastic removable gingiva for oral hygiene model lower jaw, held in place by the model teeth



# AG-3 accessories and standard teeth

By changing the gingivae, AG-3 models can be transformed into AG-3 H dental hygiene models as shown on page 51. Further accessories can be found there.

**AG-3 WOKH KR** like AG-3 WOKH, however in red-transparent execution

**AG-3 WUKH KR** like AG-3 WUKH, however in red-transparent execution



**AG-3 ROK1** back plate for AG-3 OK model jaw  
**AG-3 RUK1** back plate for AG-3 UK model jaw  
 the back plates are necessary for installation of the dental model in a frasaco phantom head

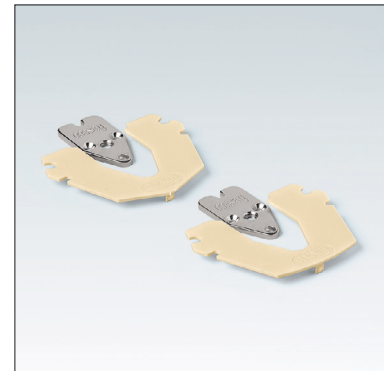

**AN-4 RM** spare part: threaded metal plate for dental models series ANA-4 (V), ANKA-4 (V), AG-3, A-PB and A-PZ for screw-in or magnetic fixation in frasaco phantom heads

**SZ-4** screwdriver for all frasaco models with multi-head screws, as well as for Philips-screws as used in the model range ANA-4 (V)



**AG-3 Z** set of 32 gnathologically contoured model teeth in hard thermosetting material with screws, to fit AG-3 models

**AG-3 Z 28** set of 28 gnathologically contoured model teeth in hard thermosetting material with screws, to fit AG-3 models

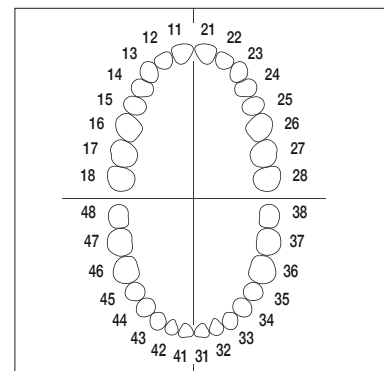

**AG-3 ZE 010** bag containing 10 individual model teeth of the same position to fit AG-3 models, with screws

**AG-3 ZE 100** bag containing 100 individual model teeth of the same position to fit AG-3 models, with screws



# AG-3 special teeth



**AG-3 ZP..**

for AG-3 models frasco can offer teeth with special preparations according to customers' specification. Please let us know the quantities required and provide a master preparation cut on an AG-3 ZE standard tooth. Pictures of all currently available teeth with preparations will be supplied upon request



**AG-3 ZP..**

diastema: the two model teeth AG-3 ZP11 99-001 and AG-3 ZP21 99-001 together represent a diastema situation



**AG-3 ZP..**

front dental trauma: the fractured teeth AG-3 ZP11 99-002 and AG-3 ZP21 99-002 can be treated with the aid of a frasco strip crown size 112 and 212



**AG-3 AE**

abrasion model consisting of upper and lower corresponding to the AG-3 series, but the screw-retained teeth show heavy abrasion and erosion. The AG-3 model series have thus been extended to include a further potential use



**AG-3 AE Z 901**

set of teeth for model AG-3 AE consisting of 32 teeth with abrasions and erosions

**AG-3 ZAE.. 901**

individual model teeth with abrasion and erosion

# AG-3 special teeth

**AG-3 AW** upper and lower model bases and removable gingiva corresponding to AG-3. Instead of model teeth (position 1 -7) only tooth preparations for waxing exercises are mounted. A complete model tooth can be sculpted on each tooth preparation. Wisdom teeth corresponding to teeth of series AG-3 ZE

on request standard models AG-3 W 20 and AG-3 28 are also available with tooth stumps



**AG-3 AW Z 901** set with 28 model teeth preparations for waxing up exercises, includes screws

**AG-3 ZAW.. 901** individual model tooth preparation for waxing up exercises, includes screw, optional assortment

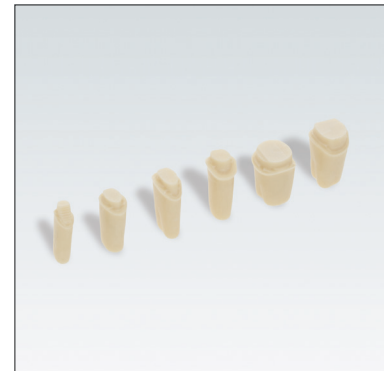

**AG-3 ZEG** For examinations:  
model teeth with screws, root part marked for identification  
optional assortment

exclusively delivered directly to the institutional examining committees



**AG-3 ZEF** For examinations:  
model teeth made of fluorescent material with screws, optional assortment. These patent protected exam teeth can easily be distinguished from standard model teeth by means of an ultraviolet lamp while staying fixed in the jaw model  
exclusively delivered directly to the institutional examining committees

**UV-L** ultraviolet testing lamp for easy identification of AG-3 ZEF exam teeth



**AG-3 ZSD.. 300** new version of frasco 2-layer posterior teeth. Enamel made of new frasco adamant-material with noticeable difference in hardness between enamel and dentine during preparation

upper	24, 25, 26, 27
lower	46



# AG-3 special teeth



**AG-3 ZSD.. 300** new version of frasco 2-layer anterior teeth, enamel made of new, frasco translucent adamant-material (suitable for aesthetic dentistry) with noticeable difference in hardness between enamel and dentine during preparation  
 upper 11, 12, 13, 21, 22, 23,



**AG-3 ZSDP.. 300** new version of frasco 3-layer teeth simulating enamel, dentine and pulp made of new frasco adamant-material with noticeable difference in hardness between enamel and dentine during preparation, red pulp tissue-like. Red pulp shining through if approached too closely during preparation  
 upper 21, 24, 26  
 lower 46



**AG-3 ZK.. V1** Matching model AG-3 we can offer model teeth with undermining caries, which can be recognized in the new, soft version 1 with dental X-ray and treated realistically.  
 This program is constantly being expanded. Please request a list of the currently available variants. In addition, we also manufacture model teeth according to customer specifications. Please tell us your exact requirements and send us an AG-3 ZE model tooth prepared according to your ideas as a sample.



**AG-3 ZSDK.. 300 V1** like AG-3 ZSD.. 300 (enamel-dentine), but with undermining caries version 1; available for upper 21 approximal, upper 24 mesial and distal, upper 26 occlusal and lower 46 occlusal and mesial  
 This program is constantly being expanded. Please request a list of the currently available variants. In addition, we also manufacture model teeth according to customer specifications. Please tell us your exact requirements.



**AG-3 ZSDPK.. 300 V1** like AG-3 ZSDP.. 300 (enamel-dentine-pulp), but with undermining caries version 1; available for upper 21 approximal, upper 24 mesial and distal, upper 26 occlusal and lower 46 occlusal and mesial  
 This program is constantly being expanded. Please request a list of the currently available variants. In addition, we also manufacture model teeth according to customer specifications. Please tell us your exact requirements.

# AG-3 special teeth

## AG-3 ZPUK

model teeth with root canals, with screws, fitting AG-3 models, execution in transparent plastic material with red pulpal walls and ivory crowns in hard thermosetting material for pre-clinical training in root canal treatment and cavity preparation  
 upper 21, 24, 26  
 lower 46



## AG-3 ZPUR

model teeth with root canals fitting AG-3 models, with screws, execution in hard thermosetting material, ivory crowns and roots with red pulpal walls for pre-clinical training in root canal treatment and cavity preparation, suitable for x-ray control  
 upper 21, 24, 26  
 lower 46

\*cross-sections of teeth shown for demonstration purposes only



## AG-3 ZPURM

model teeth with root canals fitting AG-3 model bases, ivory crowns and roots with red pulpal walls for pre-clinical endo training under x-ray control, already accessed.  
 upper 21, 24 and 26

\*cross-sections of teeth shown for demonstration purposes only

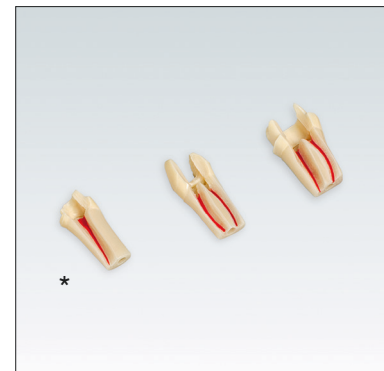

## AG-3 ZPURK

model teeth with root canals fitting AG-3 model bases, ivory crowns and roots with red pulpal walls for pre-clinical endo training under x-ray control. In addition to these features, teeth have undermining caries: are available as upper 21 approximal, upper 24 mesial and buccal, upper 26 occlusal and lower 46 occlusal and mesial

\*cross-sections of teeth shown for demonstration purposes only

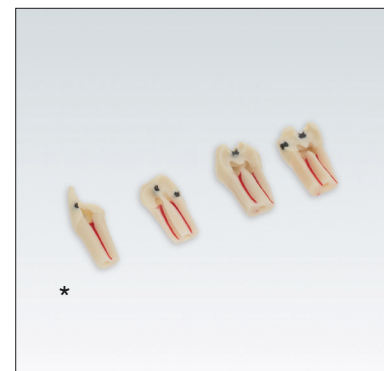

## AG-3 ZEE

model teeth fitting AG-3 models, with screws, simulating the situation after root canal treatment of incisors, premolars and molars, access holes are sealed with gutta-percha. Suitable for training the fabricating direct and indirect posts with plastic or non-plastic (metallic) materials  
 upper 14, 21, 24, 26

**Our range of model teeth series AG-3 for endodontic exercises please find on pages 34 and 35**



# AG-3 partially dentate upper model jaws



partially dentate upper model jaw, execution in hard thermosetting plastic material, elastic removable gingiva

the following models are available ex stock:

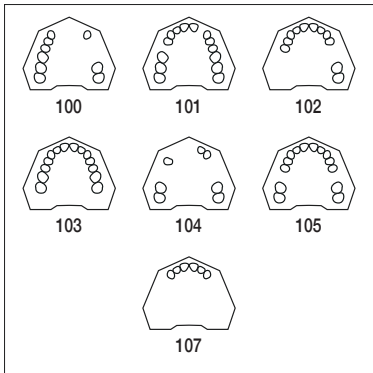

- AG-3 TOK 100**
- AG-3 TOK 101**
- AG-3 TOK 102**
- AG-3 TOK 103**
- AG-3 TOK 104**
- AG-3 TOK 105**
- AG-3 TOK 107**

8 7 6 5 4 3		3	7 8
8 7 6 4 3 2 1		1 3 4 5 6 7 8	
		5 4 3 2 1	1 2 3 4 7 8
		7 6 5 4 3 2 1	1 2 3 4 5 6 7
8 7	4		2 3 7 8
8 7	5 4 3 2 1		1 2 3 4 5 7 8
	3 2 1		1 2 3



elastic removable gingiva for upper jaw, positioned over the model base, held in place by the model teeth suitable for AG-3 TOK

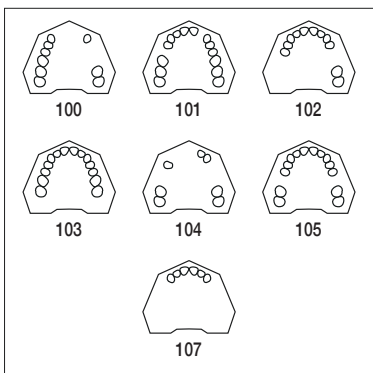

- AG-3 TWOK 100**
- AG-3 TWOK 101**
- AG-3 TWOK 102**
- AG-3 TWOK 103**
- AG-3 TWOK 104**
- AG-3 TWOK 105**
- AG-3 TWOK 107**

8 7 6 5 4 3		3	7 8
8 7 6 4 3 2 1		1 3 4 5 6 7 8	
		5 4 3 2 1	1 2 3 4 7 8
		7 6 5 4 3 2 1	1 2 3 4 5 6 7
8 7	4		2 3 7 8
8 7	5 4 3 2 1		1 2 3 4 5 7 8
	3 2 1		1 2 3

# AG-3 partially dentate lower model jaws

partially dentate lower model jaw, execution in hard thermosetting plastic material, elastic removable gingiva

the following models are available ex stock:

<b>AG-3 TUK 201</b>	8 7 6 5 4 3 2 1		1 2 3 4 5	7 8
<b>AG-3 TUK 207</b>	5 4 3		3 4 5	7 8
<b>AG-3 TUK 218</b>	3		3	
<b>AG-3 TUK 219</b>	8 7 6 5 4 3 2 1		1 2 3 4	7 8
<b>AG-3 TUK 221</b>	7 6 5 4 3 2 1		1 2 3 4 5	7
<b>AG-3 TUK 228</b>	7 6 5 4 3 2 1		1 2 3 4 5 6 7	
<b>AG-3 TUK 229</b>	8 7	5 4 3 2 1		1 2 3 4 5 7 8
<b>AG-3 TUK 231</b>	5 4 3 2 1		1 2 3 4 5	

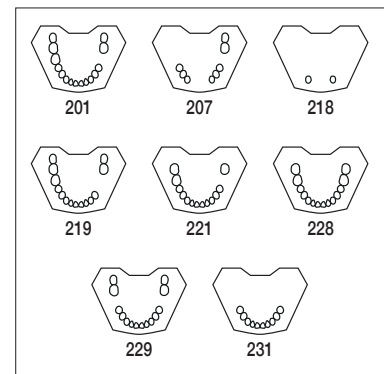

elastic removable gingiva for lower jaw, positioned over the model base, held in place by the model teeth suitable for AG-3 TUK

<b>AG-3 TWUK 201</b>	8 7 6 5 4 3 2 1		1 2 3 4 5	7 8
<b>AG-3 TWUK 207</b>	5 4 3		3 4 5	7 8
<b>AG-3 TWUK 218</b>	3		3	
<b>AG-3 TWUK 219</b>	8 7 6 5 4 3 2 1		1 2 3 4	7 8
<b>AG-3 TWUK 221</b>	7 6 5 4 3 2 1		1 2 3 4 5	7
<b>AG-3 TWUK 228</b>	7 6 5 4 3 2 1		1 2 3 4 5 6 7	
<b>AG-3 TWUK 229</b>	8 7	5 4 3 2 1		1 2 3 4 5 7 8
<b>AG-3 TWUK 231</b>	5 4 3 2 1		1 2 3 4 5	

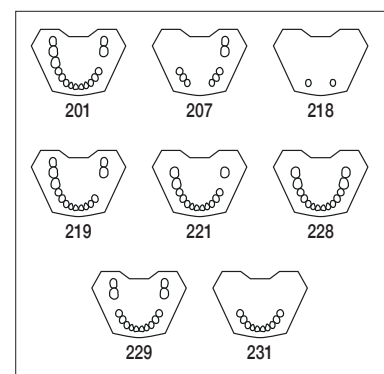



# AG-3 rubber moulds



**AG-3 G**

rubber moulds for casting plaster study models, suitable for AG-3. Partially dentate models can be created by blocking-out segments



**AG-3 ZP**

transparent centric plate with four guidance pins, fixing screw and M6 mounting thread to be placed upon the rubber mould, models cast from rubber moulds can thus be mounted in frasaco phantom heads or articulators

package containing: 1 centric plate, 1 fixing screw, 5 mounting threads

**Note: The rubber moulds AG-3 G are not included in the AG-3 ZP set**

**AG-3 ZPB**

re-fill pack containing 10 mounting threads



# standard working model series A-3

The working model corresponds to a permanent dentition. The model base is made of hard plastic material, where the upper and lower jaws occlude in a stable intercuspitation with 32 screwable teeth (A-3 Z) made of thermosetting plastic. The socket allows screwing into frasaco phantom heads.

Occlusal anatomy between prosthetic teeth and natural teeth.

Intercuspitation:

- Anterior relationship: minimum vertical overbite, slight canine guidance, dependant upon the inclination of the effective condylar paths
- Premolar to first molar region: tooth relationship = 1 : 2
- Second and third molar region: tooth relationship = 1 : 1

Gingiva:

Hard gingiva modellation.

Main use:

In pre-clinical, prosthetic propaedeutic courses and in dental techniques

**A-3** upper and lower model jaws in a stable intercuspitation (32 teeth)



**A-3 DA** upper and lower model jaws combined in a demonstration articulator allowing simple functional movements



**A-3 DAD 16** dental model A-3 DA with support

**A-3 DAD 16 K** dental model A-3 DA with hinged support for different treatment positions

**D-16** support

**D-16 K** hinged support

**DA** demonstration articulator for fixation to frasaco dental models



# A-3 standard teeth, preparations and special teeth

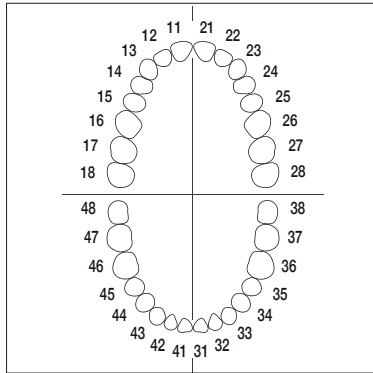

## A-3 Z

set of 32 model teeth, execution in hard thermosetting plastic material to fit A-3 models, with screw

## A-3 ZE 010

bag containing 10 individual model teeth of the same position to fit A-3 models, with screws

## A-3 ZE 100

bag containing 100 individual model teeth of the same position to fit A-3 models, with screws

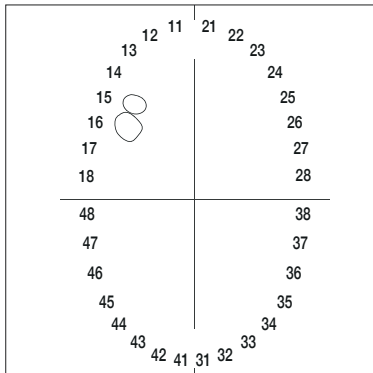

## A-3 ZPI

inlay preparations  
available for the following teeth:  
without undercuts, e.g. for inlays:  
upper 15, 16

this article is not available from stock. The minimum order quantity is 100 pieces.

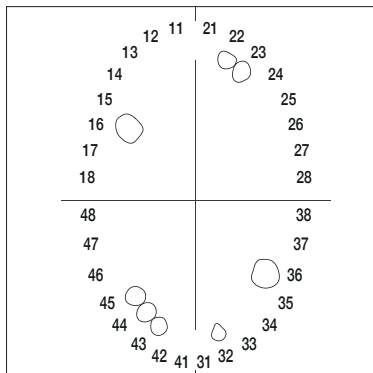

## A-3 ZPK

crown preparations of different preparation methods  
available for the following teeth:  
upper 16  
upper 22, 23  
lower 32, 36  
lower 43, 45  
lower 44 (partial crown)

this article is not available from stock. The minimum order quantity is 100 pieces.

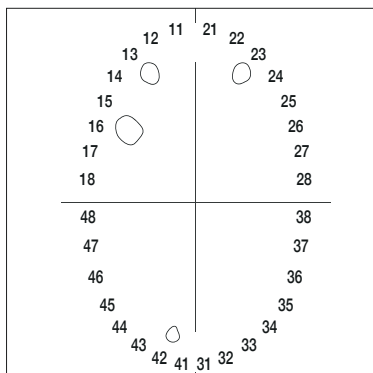

## A-3 ZPS

preparations for posts  
available for the following teeth:  
upper 13, 16  
upper 23  
lower 42

this article is not available from stock. The minimum order quantity is 100 pieces.



## A-3 ZEG

For examinations:  
model teeth with screws, root part marked for identification  
optional assortment

exclusively delivered directly to the institutional examining committees

# A-3 accessories and rubber moulds

**P-Z**

removable elastic tongue

The tongue is fixed to the model with a screw. To retrofit existing models, the tongue must be adhered to the model.

We recommend the adhesive A-P K G.

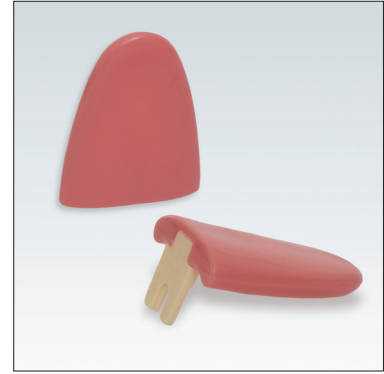

**SZ-4**

screwdriver for all frasaco models with multi-head screws, as well as for Philips-screws as used in the model range ANA-4 (V)



**A-3 G**

rubber moulds for casting plaster study models, suitable for A-3 Partially dentate models can be created by blocking out segments



**A-3 ZP**

transparent centric plate with four guidance pins, fixing screw and M6 mounting thread to be placed upon the rubber mould, models cast from rubber moulds can thus be mounted in frasaco phantom heads or articulators

package containing: 1 centric plate, 1 fixing screw, 5 mounting threads

**Note: the rubber moulds A-3 G are not included in the A-3 ZP set.**



**A-3 ZPB**

re-fill pack containing 10 mounting threads

# A-3 partially dentate upper model jaws



partially dentate upper model jaw  
execution in hard thermosetting plastic material

The following models are available ex stock:

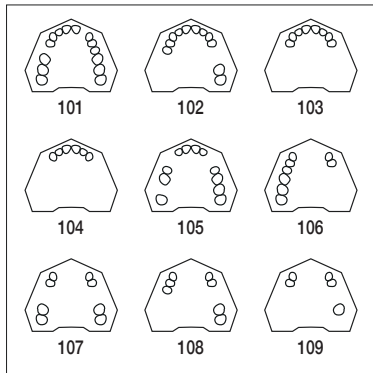

- A-3 TOK 101**
- A-3 TOK 102**
- A-3 TOK 103**
- A-3 TOK 104**
- A-3 TOK 105**
- A-3 TOK 106**
- A-3 TOK 107**
- A-3 TOK 108**
- A-3 TOK 109**

```

8 7 6 4 3 2 1 | 1 3 4 5 6 7 8
      5 4 3 2 1 | 1 2 3 4 7 8
      4 3 2 1 | 1 2 3 4
      3 2 1 | 1 2 3
8 6 5 2 1 | 1 2 5 6 7 8
8 7 6 5 4 3 | 3 4
8 7 4 3 | 3 4 7 8
      5 4 3 | 3 4 7 8
      4 3 | 3 4 7
    
```

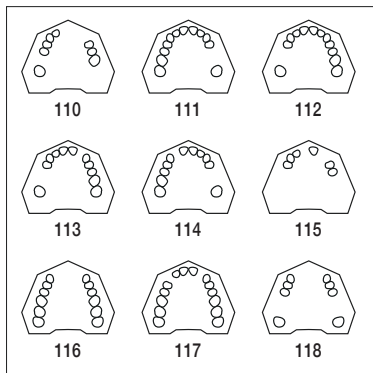

- A-3 TOK 110**
- A-3 TOK 111**
- A-3 TOK 112**
- A-3 TOK 113**
- A-3 TOK 114**
- A-3 TOK 115**
- A-3 TOK 116**
- A-3 TOK 117**
- A-3 TOK 118**

```

7 5 4 3 2 | 4 5 6
7 6 5 4 3 2 1 | 1 2 3 4 7
7 4 3 2 1 | 1 2 3 4 5 6 7
7 4 3 2 1 | 1 3 4 5 6 7
7 6 5 4 3 1 | 1 2 3 4 7
      4 3 2 | 1 4 5
8 7 6 5 4 3 | 3 4 5 6 7 8
8 7 6 5 4 2 1 | 1 3 4 5 6 7 8
8 5 4 3 | 3 4 5 8
    
```

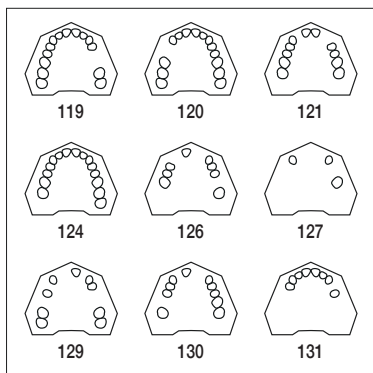

- A-3 TOK 119**
- A-3 TOK 120**
- A-3 TOK 121**
- A-3 TOK 124**
- A-3 TOK 126**
- A-3 TOK 127**
- A-3 TOK 129**
- A-3 TOK 130**
- A-3 TOK 131**

```

8 7 6 5 4 3 2 1 | 1 2 3 4 7 8
8 7 6 3 2 1 | 1 2 3 4 5 6 7 8
7 6 5 4 3 1 | 1 4 5 6 7
7 6 5 4 3 2 1 | 1 2 3 4 5 6 7 8
      6 5 4 1 | 3 4 5 7
      3 | 3 6
8 7 5 3 | 1 3 4 7 8
7 5 4 3 1 | 3 4 5 6 7
      4 3 2 1 | 1 2 3 5
    
```

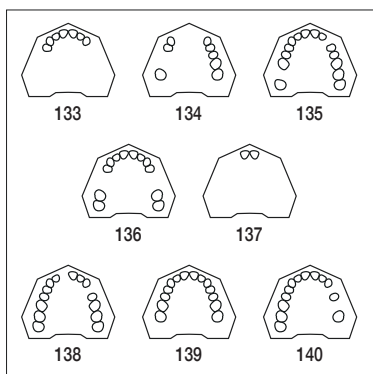

- A-3 TOK 133**
- A-3 TOK 134**
- A-3 TOK 135**
- A-3 TOK 136**
- A-3 TOK 137**
- A-3 TOK 138**
- A-3 TOK 139**
- A-3 TOK 140**

```

      4 3 2 1 | 1 2 3
7 4 3 | 3 4 5 6 7
8 6 5 4 3 2 1 | 1 2 4 5 6 7 8
8 7 4 3 2 1 | 1 2 3 4 7 8
      1 | 1
8 7 6 5 4 3 2 | 1 2 3 5 6 7 8
7 6 5 4 3 2 1 | 1 2 3 4 5 6 7
8 7 6 5 4 3 2 1 | 1 2 3 5 7
    
```

# A-3 partially dentate lower model jaws

partially dentate lower model jaw  
execution in hard thermosetting plastic material

The following models are available ex stock:

<b>A-3 TUK 201</b>	8 7 6 5 4 3 2 1		1 2 3 4 5	7 8
<b>A-3 TUK 202</b>	5 4 3 2 1		1 2 3 4	
<b>A-3 TUK 203</b>	4 3 2 1		1 2 3 4	
<b>A-3 TUK 204</b>	8 7		3 2 1	1 2 3 7 8
<b>A-3 TUK 205</b>			3 2 1	1 2 3
<b>A-3 TUK 206</b>	8 7 6 5 4 3		3 4	
<b>A-3 TUK 207</b>	5 4 3		3 4 5	7 8
<b>A-3 TUK 208</b>	8 7		3	3 7 8

<b>A-3 TUK 209</b>			4 3	3 4 7
<b>A-3 TUK 210</b>	7 5 3 2		2 3 4 5 6	
<b>A-3 TUK 211</b>	4 3 2 1		1 2 3 4 5	
<b>A-3 TUK 212</b>	8 7 5 4 3 2 1		1 2 3 4 5 6 7 8	
<b>A-3 TUK 214</b>	8 7 6 5 4 3 2 1		1 2 3 4 5 6 8	

<b>A-3 TUK 216</b>	5 4		4 5	
<b>A-3 TUK 218</b>	3		3	
<b>A-3 TUK 219</b>	5 4		3 4 5	7 8
<b>A-3 TUK 221</b>	4 3 2 1		1 2 3 4	7 8

<b>A-3 TUK 227</b>	5 4 3		3 4 5	
<b>A-3 TUK 228</b>	7 6 5 4 3 2 1		1 2 3 4 5 6 7	
<b>A-3 TUK 229</b>	8 7 6 4 3 2 1		1 2 3 4 5 7 8	
<b>A-3 TUK 230</b>	8 7 6 5 4		4 5 6 7 8	
<b>A-3 TUK 231</b>	7 6 5 4 3 2 1		1 2 3 4	
<b>A-3 TUK 232</b>	4 3 2 1		1 2 3	
<b>A-3 TUK 233</b>	4 3 2 1		1 2 3 4 5 6 7 8	

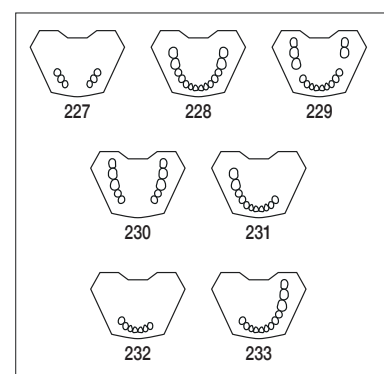
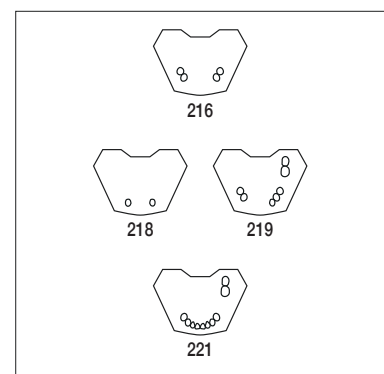
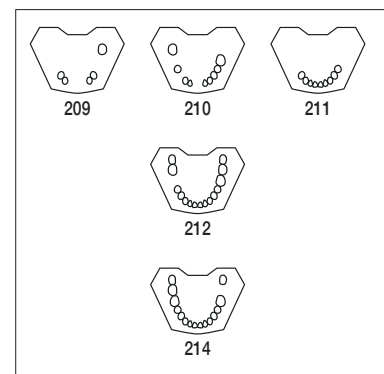
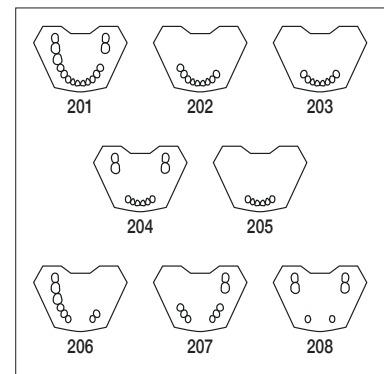



## special models

The frasaco standard model series allow comprehensive pre-clinical training and are suitable for simulation of very different patient cases in phantom courses thanks to a wide range of special teeth. frasaco also provides special models that enable additional applications, particularly in postgraduate courses. These models are mainly designed for multiple use. Accessories and materials required for reprocessing can be found along with the products in this catalogue.



# preparation training

- A-PTS** preparation trainer kit  
 mounting plate for frasco phantom heads with clip device for preparation trainers to exercise typical preparations  
 complete with: 2 square transparent plastic blocks printed with 13 different preparation designs in total, millimetric film for three-dimensional control and mounting key
- A-PT** preparation trainer  
 2 square transparent plastic blocks printed with 13 different preparation designs in total, millimetric film for three-dimensional control
- A-PTM** 2 square plastic blocks simulating enamel, dentine and pulp layers made from 3 different layers of hard thermosetting frasco tooth material, printed with 13 different preparation designs in total, millimetric film for control
- A-PT 99-001** 2 square transparent plastic blocks printed with simple geometrical shapes "OSY" for preparation training, millimetric film for three-dimensional control
- A-PTM 99-001** 2 square plastic blocks simulating enamel, dentine and pulp layers printed with simple geometrical shapes „OSY“ for preparation training, millimetric film for control
- A-PTSM** enamel, dentine, pulp preparation trainer kit  
 mounting plate for frasco phantom heads with clip device for preparation trainers made from 3 different layers of hard thermosetting frasco tooth material  
 complete with: 2 square plastic blocks printed with 13 different preparation designs in total, millimetric film for control and mounting key
- 1531-SRM** mounting plate for screw-in or magnetic fixation of preparation or endodontic trainers in frasco phantom heads
- 1534-SRM** mounting plate used for fitting 2 frasco preparation trainers in one of the V-shaped positions left and right, intended to simulate the dental arch.  
 They enable optional screw-retention or retention using magnetic mounting plates in frasco phantom heads

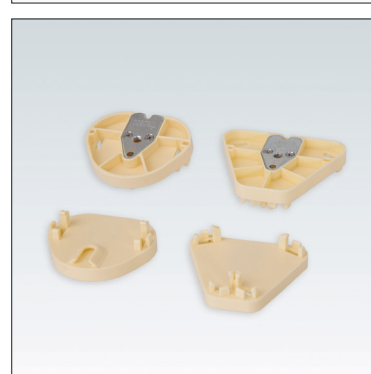
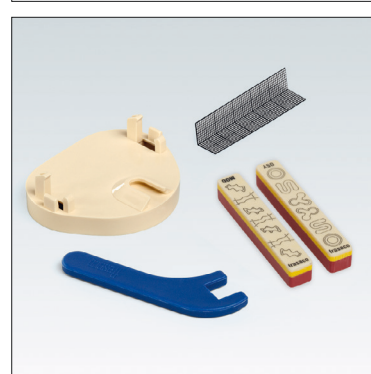
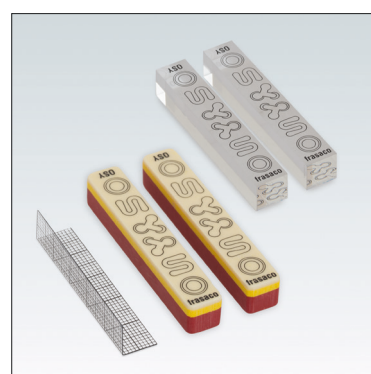
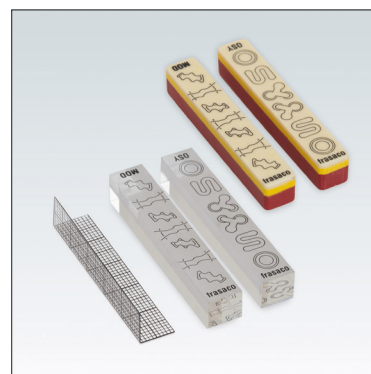
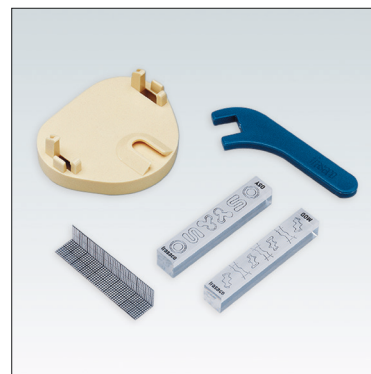

# endodontic exercises



**A-ETE-0**  
**A-ETE-10**  
**A-ETE-20**  
**A-ETE-30**

endo trainer  
 transparent cylinder to practice root canal preparation,  
 round plastic material to magnify the root canal,  
 root canals with curves of 0°, 10°, 20° or 30°  
 canal with red pulpal walls

**A-ETK-0**  
**A-ETK-10**  
**A-ETK-20**  
**A-ETK-30**

endo trainer  
 transparent cylinder to practice root canal preparation,  
 round plastic material to magnify the root canal,  
 root canals with curves of 0°, 10°, 20° or 30°  
 canal with non-coloured pulpal walls



**A-ETEL-0**  
**A-ETEL-10**  
**A-ETEL-20**  
**A-ETEL-30**

endo trainer with open apex  
 transparent cylinder to practice root canal preparation,  
 round plastic material to magnify the root canal,  
 root canals with curves of 0°, 10°, 20° or 30°  
 canal with red pulpal walls

In this version of the well-known frasco endo trainers the apex has been opened, so over-instrumentation can be detected

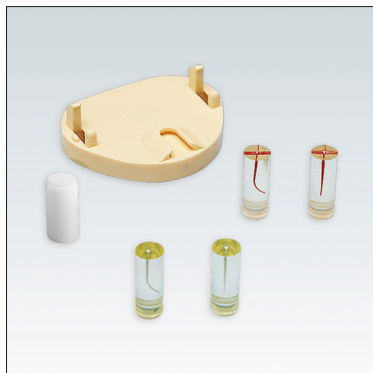

**A-ETS**

endo trainer kit  
 mounting plate for frasco phantom heads with slide device  
 for transparent endo cylinders to practice root canal preparation  
 complete with:  
 2 endo trainers with root canal with red pulpal walls  
 2 endo trainers with root canal with non-coloured pulpal walls  
 root canals with curves of 0° and 20°  
 1 cover hood for blind exercises

**A-ETA**

cover hood for blind exercises

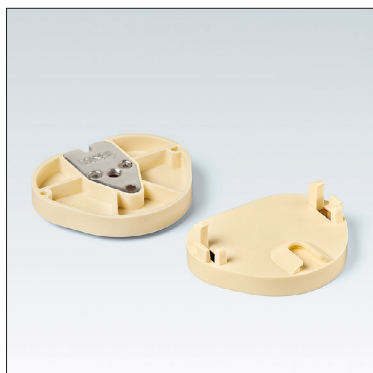

**1531-SRM**

mounting plate for screw-in or magnetic fixation of preparation or endodontic trainers in frasco phantom heads



**AG-3 ZPUK**

model teeth with root canals, with screws, fitting AG-3 models,  
 execution in transparent plastic material  
 with red pulpal walls and ivory crowns in hard thermosetting material  
 for pre-clinical training in root canal treatment and cavity preparation  
 upper 21, 24, 26  
 lower 46



# endodontic exercises

## AG-3 ZPUR

model teeth with root canals fitting AG-3 models, with screws, execution in hard thermosetting material, ivory crowns and roots with red pulpal walls for pre-clinical training in root canal treatment and cavity preparation, suitable for x-ray control

upper 21, 24, 26  
lower 46



## AG-3 ZEE

model teeth fitting AG-3 models, with screws, simulating the situation after root canal treatment of incisors, premolars and molars, access holes are sealed with gutta-percha. Suitable for training the making of direct and indirect posts with plastic or non-plastic (metallic) materials

upper 14, 21, 24, 26



## ANA-4 ZPUK

model teeth with root canals similar to AG-3 ZPUK, with screws, however fitting models ANA-4 (V)

upper 21, 24, 26  
lower 46



## ANKA-4 ZPUK

model teeth with root canals as above, however fitting the frasaco click system models ANKA-4 (V)

upper 21, 24, 26  
lower 46



## ANA-4 ZPUR

model teeth with root canals similar to AG-3 ZPUR, with screws, however fitting models ANA-4 (V)

upper 21, 24, 26  
lower 46

## ANKA-4 ZPUR

model teeth with root canals as above, however fitting the frasaco click system models ANKA-4 (V)

upper 21, 24, 26  
lower 46

## ANA-4 ZEE

model teeth with gutta-percha filling similar to AG-3 ZEE, with screws, however fitting models ANA-4 (V)

upper 14, 21, 24, 26

## ANKA-4 ZEE

model teeth with root canals as above, however fitting the frasaco click system models ANKA-4 (V)

upper 14, 21, 24, 26



# endodontic exercises



**ANA-4 VEM 901** upper and lower models of the ANA-4 V series with a total of 4 endo-teeth with anatomical roots of the ANA-4 ZPUKN series pre-assembled in positions 21, 24, 26 and 46. Tooth 21 fits the integrated locking mechanism, while the posterior teeth are fixed with plastic screws. All steps of a root canal treatment can be simulated. A crown part made of the proven frasco tooth material gives a realistic feeling of treatment during trepanation exercises. Red shaded root canals in the transparent root parts can be prepared and filled according to a natural tooth.



**ANA-4 VE OK 901** upper jaw model as described above, but the model jaw is prepared for fitting a total of 3 ANA-4 ZPUKN series endodontic teeth in positions 21, 24 and 26. The endodontic teeth themselves must be ordered separately for this version.

**ANA-4 VE UK 901** lower jaw model as described above, but the model jaw is prepared for fitting one ANA-4 ZPUKN series endodontic tooth in position 46. The endodontic tooth itself must be ordered separately for this version.

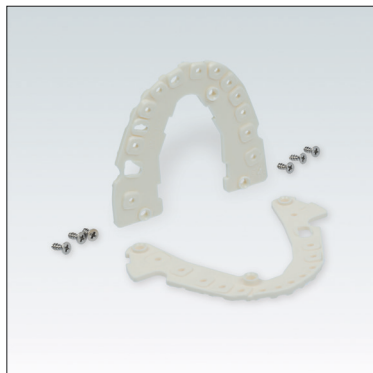

**ANA-4 SPE OK 001** mounting plate with screws for changing existing upper models of the ANA-4 (V) series to the new frasco endo-teeth with whole root, as shown on pages 11 to 13 and 37, to allow fixing at positions 21, 24 and 26.

**ANA-4 SPE UK 001** mounting plate with screws for changing existing lower models of the ANA-4 (V) series to the new frasco endo-teeth with whole root, as shown on pages 11 to 13 and 37, to allow fixing at position 46.



**ANA-4 VEM 903** upper and lower models of the ANA-4 V series with a total of 8 endo-teeth with anatomical roots of the ANA-4 ZPUKN series pre-assembled in positions 11, 16, 21, 24, 26, 36, 45 and 46. Teeth 11 and 21 fit the integrated locking mechanism, while the posterior teeth are fixed with plastic screws. All steps of a root canal treatment can be simulated. A crown part made of the proven frasco tooth material gives a realistic feeling of treatment during trepanation exercises. Red shaded root canals in the transparent root parts can be prepared and filled according to a natural tooth.



**ANA-4 VE OK 903** upper jaw model as described above, but the model jaw is prepared for fitting a total of 5 ANA-4 ZPUKN series endodontic teeth in positions 11, 16, 21, 24 and 26. The endodontic teeth themselves must be ordered separately for this version.

**ANA-4 VE UK 903** lower jaw model as described above, but the model jaw is prepared for fitting a total of 3 ANA-4 ZPUKN series endodontic teeth in positions 36, 45 and 46. The endodontic teeth themselves must be ordered separately for this version.

# endodontic exercises

**ANA-4 SPE OK 003** mounting plate with screws for changing existing upper models of the ANA-4 (V) series to the new frasaco endo-teeth with whole root, as shown on pages 11 to 13 and 37, to allow fixing at positions 11, 16, 21, 24 and 26.

**ANA-4 SPE UK 003** mounting plate with screws for changing existing lower models of the ANA-4 (V) series to the new frasaco endo-teeth with whole root, as shown on pages 11 to 13 and 37, to allow fixing at positions 36, 45 and 46.

**ANA-4 ZPUKN** training teeth with anatomical roots that simulate all steps of a root canal treatment. Anterior teeth 11 and 21 are supplied without screws, as they are fixed in the model base with an integrated locking mechanism, while posterior teeth are fixed with supplied plastic screws. A crown part made of the proven frasaco tooth material gives a realistic feeling during trepanation exercises. The red shaded root canals in the transparent root part can be treated and filled like a natural tooth.

Detailed description on pages 11-13

upper 11, 16, 21, 24, 26

lower 36, 45, 46

**ANA-4 ZPUKN TM** endodontic training teeth with anatomical roots of the ANA-4 ZPUKN series are also available in an prepared version. The TM version is accessed according to the principles of minimally invasive technique.

upper 11, 16, 21, 24, 26

lower 36, 45, 46

**ANA-4 ZPUKN TT** endodontic training teeth with anatomical roots of the ANA-4 ZPUKN series are also available in a prepared version. The TT version is accessed according to the traditional principles.

upper 11, 16, 21, 24, 26

lower 36, 45, 46

## A-REEM 901

X-ray and endometry model with a total of 4 endodontic teeth with anatomical roots of the ANA-4 ZPURN series pre-assembled in positions 21, 24, 26 and 46. All steps of a root canal treatment including an electro-metric length determination can be simulated. A crown section made of the proven frasaco tooth material gives a realistic feeling of treatment during trepanation exercises. Root canals and tooth roots are radiolucent and can be examined, prepared and filled like a natural tooth. A conductive medium is additionally required for root canal length measurement. Connections for an endometry measuring device are available as well as recesses for X-ray films or digital sensors.



# endodontic exercises



**A-REE OK 901**

Upper jaw model as described above, but the X-ray and endometry model is prepared for the acquisition of a total of 3 ANA-4 ZPURN series endodontic teeth in positions 21, 24 and 26. The endodontic teeth themselves must be ordered separately for this version.

**A-REE UK 901**

Lower jaw model as described above, but the X-ray and endometry model is prepared for the acquisition of an endodontic tooth of the series ANA-4 ZPURN in position 46. The endodontic tooth itself must be ordered separately for this version.



**A-REEM 903**

X-ray and endometry model with a total of 8 endodontic teeth with anatomic roots of series ANA-4 ZPURN in positions 11, 16, 21, 24, 26, 36, 45 and 46 pre-assembled. All steps of a root canal treatment including an electrometric length determination can be simulated. A crown section made of the proven frasco tooth material gives a realistic feeling of treatment during trephination exercises.

Root canals and roots are radiolucent and can be examined, prepared and filled according to a natural tooth. A conductive medium is also required for root canal length measurement. Connections for an endometrometer are available as well as recesses for X-ray films or digital sensors.



**A-REE OK 903**

Upper jaw model as described above, but the X-ray and endometry model is prepared for the acquisition of a total of 5 endodontic teeth of the ANA-4 ZPURN series in positions 11, 16, 21, 24 and 26. The endodontic teeth themselves must be ordered separately for this version.

**A-REE UK 903**

Lower jaw model as described above, but the X-ray and endometry model is prepared for the acquisition of a total of 3 endodontic teeth of the ANA-4 ZPURN series in positions 36, 45 and 46. The endodontic teeth themselves must be ordered separately for this version.



**A-REE LG**

Conductive medium for root canal length measurement in frasco endometry models of the A-REE series. With the contents of the bottle, model jaws can be completely filled up to 9 times.

# endodontic exercises

**ANA-4 ZPURN** Training teeth with anatomical roots with which all steps of a root canal treatment can be simulated. Anterior teeth 11 and 21 are supplied without screws because they are held in the model base with an integrated locking mechanism, while posterior teeth are fixed with plastic screws supplied. A crown part made of the proven frasco tooth material gives a realistic feeling of processing during trepanation exercises. Root canals and tooth roots are radiolucent and can be examined, prepared and filled like a natural tooth.

upper 11, 16, 21, 24, 26  
lower 36, 45, 46



**ANA-4 Z3RN-11** In this further development of our practice teeth with anatomical roots, the enamel consists of a new frasco adamant material with a noticeable difference in hardness between enamel and dentine for trepanation exercises. The tooth root is made of a material that allows realistic preparation similar to natural root cement. Pulp and root tissue are simulated by soft material. Thus all steps of a root canal treatment can be simulated supported by X-ray and apex length measurement. This tooth is supplied without a screw as it is held in the model base with an integrated locking mechanism.

upper 11



**ANA-4 Z3RN-16** In this further development of our practice teeth with anatomical roots, the enamel consists of a new frasco adamant material with a noticeable difference in hardness between enamel and dentine for trepanation exercises. The tooth roots are made of a material that allows realistic preparation similar to natural root cement. Pulp and root tissue are simulated by soft material. Thus all steps of a root canal treatment can be simulated supported by X-ray and apex length measurement. This tooth is delivered with a plastic screw for fixation in the base of the tooth.

upper 16



**ANA-4 Z3RN-21** In this further development of our practice teeth with anatomical roots, the enamel consists of a new frasco adamant material with a noticeable difference in hardness between enamel and dentine for trepanation exercises. The tooth root is made of a material that allows realistic preparation similar to natural root cement. Pulp and root tissue are simulated by soft material. Thus all steps of a root canal treatment can be simulated supported by X-ray and apex length measurement. This tooth is supplied without a screw because it is held in the model base with an integrated locking mechanism.

upper 21



**ANA-4 Z3RN-24** In this further development of our practice teeth with anatomical roots, the enamel consists of a new frasco adamant material with a noticeable difference in hardness between enamel and dentine for trepanation exercises. The tooth roots are made of a material that allows realistic preparation similar to natural root cement. Pulp and root tissue are simulated by soft material. Thus all steps of a root canal treatment can be simulated supported by X-ray and apex length measurement. This tooth is attached to the root canal with a plastic screw.

upper 24





# endodontic exercises



**ANA-4 Z3RN-26** In this further development of our practice teeth with anatomical roots, the enamel consists of a new frasco adamant material with a noticeable difference in hardness between enamel and dentine for trepanation exercises. The tooth roots are made of a material that allows realistic preparation similar to natural root cement. Pulp and root tissue are simulated by soft material. Thus all steps of a root canal treatment can be simulated supported by X-ray and apex length measurement. This tooth is supplied with a plastic screw for fixation in the model base.

upper 26



**ANA-4 Z3RN-36** In this further development of our practice teeth with anatomical roots, the enamel consists of a new frasco adamant material with a noticeable difference in hardness between enamel and dentin for trepanation exercises. The tooth roots are made of a material that allows realistic preparation similar to natural root cement. Pulp and root tissue are simulated by soft material. Thus all steps of a root canal treatment can be simulated supported by X-ray and apex length measurement. This tooth is supplied with a plastic screw for fixation in the model base.

lower 36

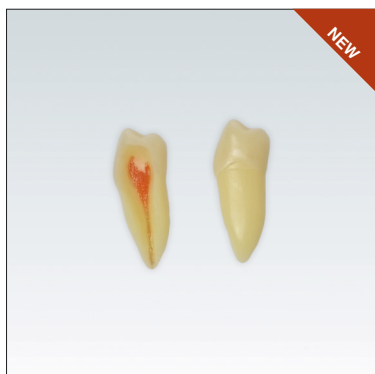

**ANA-4 Z3RN-45** In this further development of our practice teeth with anatomical roots, the enamel consists of a new frasco adamant material with a noticeable difference in hardness between enamel and dentine for trepanation exercises. The tooth root is made of a material that allows realistic preparation similar to natural root cement. Pulp and root tissue are simulated by soft material. Thus all steps of a root canal treatment can be simulated supported by X-ray and apex length measurement. This tooth is supplied with a plastic screw for fixation in the model base.

lower 45



**ANA-4 Z3RN-46** In this further development of our practice teeth with anatomical roots, the enamel consists of a new frasco adamant material with a noticeable difference in hardness between enamel and dentine for trepanation exercises. The tooth root is made of a material that allows realistic preparation similar to natural root cement. Pulp and root tissue are simulated by soft material. Thus all steps of a root canal treatment can be simulated supported by X-ray and apex length measurement. This tooth is supplied with a plastic screw for fixation in the model base.

lower 46



**ANA-4 Z3RNK..** Based on the ANA-4 Z3RN... type endodontic teeth shown above, we can offer model teeth with undermining caries, which can be identified and realistically treated in the new, soft version 1 with dental x-ray.

**Notice:**

**Our endodontic program is characterized by continuous product improvements and program additions. Please ask for the current list of available options.**



# endodontic exercises

**A-REEM BGR1** The model base A-REEM BGR1 of the X-ray and endometry model shown above can not only be used with frasaco model teeth, but is also suitable for exercises with extracted real teeth. These real teeth can be set up following the dental arch after the user has milled accurately fitting openings into the insertion plate. An additional fixation with cold curing resin is recommended. Model teeth of the ANA-4 ZE series can easily be fixed to the screw plates with Phillips screws between them. Connections for an endometrometer are available as well as recesses for X-ray films or digital sensors. A conductive medium is additionally required for root canal length measurement.



**A-RE POK 901** mounting plate with screws for upper jaw with longer support pins compared to earlier versions



**A-RE PUK 901** mounting plate with screws for lower jaw with longer support pins compared to earlier versions



**A-RE WOK** elastic removable gingiva for upper jaw

**A-RE WUK** elastic removable gingiva for lower jaw

**A-RE SET OK 99-001** Upper jaw model completely assembled using the model base A-REEM BGR1 with 14 model teeth type ANA-4 ZE, with modified screw plate A-RE POK 901 and gingiva A-RE WOK. Extracted real teeth can be used as described in A-REEM BGR1 above.



**A-RE SET UK 99-001** Lower jaw model completely assembled using the model base A-REEM BGR1 with 14 model teeth type ANA-4 ZE, with modified screw plate A-RE PUK 901 and gingiva A-RE WUK. Extracted real teeth can be used as described in A-REEM BGR1 above.



# training in implantological surgery

The frasaco A-J F range of upper and lower jaw models can be used for training purposes for all dental implantological surgery procedures under correct anatomical conditions. The models can be displayed on panoramic X-ray and represent the anatomy of an implant patient with a greatly reduced residual dentition.

Upper jaw: paranasal sinus abnormally expanded due to bone atrophy, residual dentition: 13, 23, 27

Lower jaw: 2 canals for simulating the alveolar nerve, residual dentition: 33, 37, 43

The artificial bone material corresponds to the physicommechanical properties of the human jaw bone. There is also the option of an elastic removable gingiva cover. These features not only allow drilling under realistic conditions of resistance and drilling pressure but also ensure that incisions, periostomy and suturing techniques can be practised under as realistic conditions as possible. Simulation of the mucosa of the maxillary sinus and paranasal sinus in the upper jaw even provides the opportunity of training in direct or indirect sinus lift surgery. Fitting the models into frasaco phantom heads (upper jaw with an integrated mounting thread, lower jaw with reusable metal mounting plate) provides even more realistic practice in the restricted working area of the oral cavity.

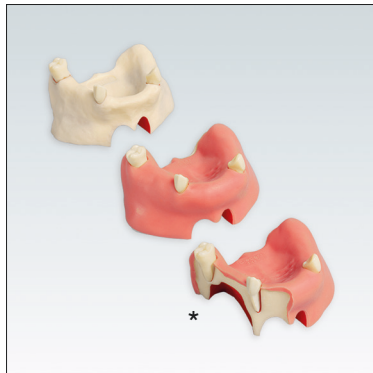

**A-J F SOK** upper jaw for implantology training with sinus membrane

**A-J F SOKW** upper jaw for implantology training with sinus membrane and soft removable gingiva

\*demo model shown not available

with the repair materials A-J F OK K, A-J F S and A-J F R the models can be reprocessed for multiple use

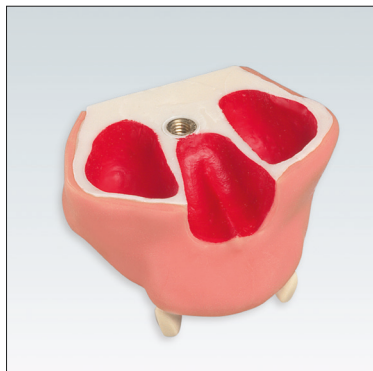

**A-J F OKW  
99-001**

upper implant model jaw similar to A-J F SOKW, however without sinus membrane and without abnormally expanded paranasal sinus due to bone atrophy, therefore only suitable for implant training but not for training sinus lift surgery

with the repair materials A-J F OK K and A-J F R the models can be reprocessed for multiple use

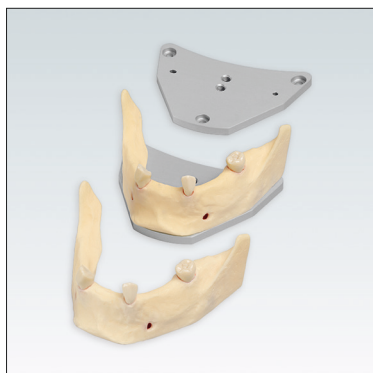

**A-J A** model mounting plate for lower jaw

**A-J F UKA** lower jaw for implantology training including model mounting plate

**A-J F UK** lower jaw for implantology training

with the repair set A-J F UK K the models can be reprocessed for multiple use

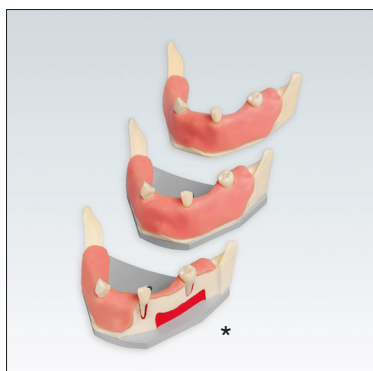

**A-J F UKW** lower jaw for implantology training with soft removable gingiva

**A-J F UKWA** lower jaw for implantology training with soft removable gingiva and model mounting plate for frasaco phantom heads

\*demo model shown not available

with the repair set A-J F UK K the models can be reprocessed for multiple use

# training in implantological surgery

**A-J F WOK** elastic, exchangeable gingiva for upper jaw model, for surgical exercises

**A-J F WUK** elastic, exchangeable gingiva for lower jaw model, for surgical exercises

**A-J F OK K** synthetic resin for reconstruction of the model base made from material similar to bone of upper implant model jaw A-J F OKW 99-001 and A-J F SOKW

**A-J F UK K** synthetic resin for reconstruction of the model base made from material similar to bone of lower implant model jaw A-J F UK

**Note: These products have been classified as hazardous goods and must be labeled and shipped in accordance with the relevant laws and regulations. This can make airfreight very costly. Please let us know in advance the exact quantities you require, so we can send you an offer detailing the additional cost.**

**A-J F S** using this upgrade set, the sinus mucosa (Schneiderian membrane) can be re-applied following a sinus-lift exercise on the A-J F SOKW model. Damaged bone material can be repaired beforehand using the A-J F OK K bone material set

**A-J F R** with this x-ray colour the maxillary sinus and paranasal sinus of the models series A-J F SOKW can be radiographically represented after reconstruction.

**Note: These products have been classified as hazardous goods and must be labeled and shipped in accordance with the relevant laws and regulations. This can make airfreight very costly. Please let us know in advance the exact quantities you require, so we can send you an offer detailing the additional cost.**

**A-JT** set consisting of 3 implant trainer plates, each 100 by 50 mm wide and 17 mm thick, made from special material similar to human bone (corresponding to bone hardness classifications D2, D3 and D4) for first drilling exercises

**A-JT D2** single implant trainer plate as above corresponding to class D2

**A-JT D3** single implant trainer plate as above corresponding to class D3

**A-JT D4** single implant trainer plate as above corresponding to class D4



# training in implantological surgery



**A-J A**

model mounting plate for frasco phantom head

**A-J KWUK**

elastic, exchangeable gingiva  
for implant training mandible, suitable for surgical exercises

**A-J K**

implant training model  
anatomical designed edentulous mandible in plastic material similar to human bone, simulated nerves, left and right at different locations, right quadrant with narrow tapering crest, fresh alveoli 31 and 32, semi-healed alveole 37, alveole 33 with bone pocket and fenestration, suitable for GTR-exercises



**A-J KWA**

implant training model set consisting of:  
edentulous implant training mandible A-J K  
elastic, exchangeable gingiva A-J KWUK  
model mounting plate A-J A



**A-J KA**

implant training model set consisting of:  
edentulous implant training mandible A-J K  
model mounting plate A-J A



**A-J KW**

implant training model set consisting of:  
edentulous implant training mandible A-J K  
elastic, exchangeable gingiva A-J KWUK



**A-J KG**

with this new version of the familiar frasco implantology model A-J K the alveoli 31, 32, 33 and 37 have been closed to provide a simplified training model with additional positions suitable for placing implants. This can also be combined with the A-J A mounting plate and A-J KWUK gingiva, as shown above

# training in implantological surgery

**B-3 CSPJW** natural, anatomically contoured upper and lower model corresponding to frasco model B-3 CSP, but with a softer removable gingiva for even more realistic impression-taking exercises. Under the gingiva is a model base made from bone-like material, which is suitable for implantology exercises. The shape and size perfectly matches the frasco models of the series ANA-4 (V) and ANKA-4 (V). Metal backplate with thread for optional screw-retention or retention using magnetic mounting plates in frasco phantom heads

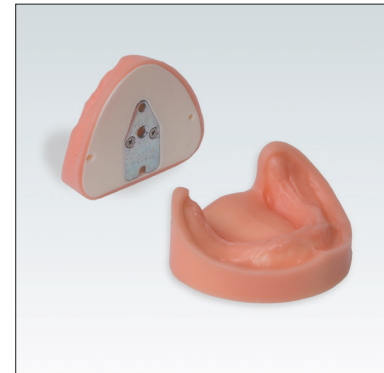

**B-3 CSPB** bite block suitable for models B-3 CSPJW and B-3 CSP

**B-3 CSPB OK** sectioned upper bite block for models B-3 CSPJW and B-3 CSP coordinated with the fully dentate lower jaw of the model series ANA-4 (V) and ANKA-4 (V)

**B-3 CSPB UK** sectioned lower bite block for models B-3 CSPJW and B-3 CSP coordinated with the fully dentate lower jaw of the model series ANA-4 (V) and ANKA-4 (V)



**B-3 CSPJ** edentulous upper and lower model corresponding to frasco model B-3 CSPJW, but without removable gingiva. The model base is manufactured from bone-like material and is ideal for implantology exercises. The shape and size perfectly match frasco models of the series ANA-4 (V) and ANKA-4 (V). Metal backplate with thread for optional screw-retention or retention using magnetic mounting plates in frasco phantom heads



**B-3 CSPJ WOK** elastic removable gingiva for the upper jaw of the edentulous model B-3 CSPJW

**B-3 CSPJ WUK** elastic removable gingiva for the lower jaw of the edentulous model B-3 CSPJW

we recommend fixing the removable gingivae to the model jaw using a few drops of our A-P K G adhesive.



**B-3 CSPJW UK 99-002** this product consists of the lower jaw of the edentulous frasco model B-3 CSPJW described above made from material similar to bone with soft removable gingiva. Implant analogues (hex system) have been placed by us in positions 33 and 43. This allows implant prosthetic treatment of an edentulous jaw to be practiced. Metal back plate with thread for screw retention or optional retention with magnet mounting plates in frasco phantom heads





# implantology and full denture exercises



**B-3 NMJW**

these edentulous upper and lower jaw models in neutral intermaxillary relationship with undercut areas correspond to the anatomy of the familiar frasaco model B-3 NM from Page 49, but with soft removable gingiva for even more realistic impressions. The gingiva covers a model base made from material similar to bone suitable for implantology exercises. Metal back plate with thread for screw retention or optional retention with magnet mounting plates in frasaco phantom heads



**B-3 NMB**

bite block suitable for models B-3 NMJW and B-3 NM

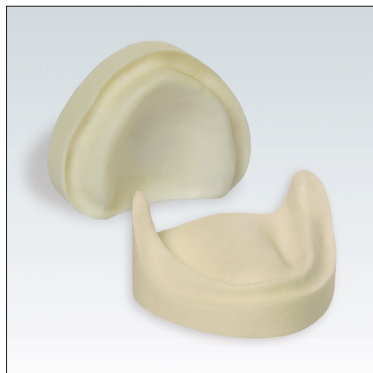

**B-3 NMJO**

these edentulous upper and lower jaw models correspond to the frasaco model B-3 NMJW, but without removable gingiva



**B-3 NMJ WOK**

soft removable gingiva for the upper jaw of the edentulous model B-3 NMJW



**B-3 NMJ WUK**

soft removable gingiva for the lower jaw of the edentulous model B-3 NMJW



**B-3 NHJW**

these edentulous upper and lower jaw models in neutral intermaxillary relationship without undercut areas correspond to the anatomy of the familiar frasaco model B-3 NH from Page 48, but with soft removable gingiva for even more realistic impressions. The gingiva covers a model base made from material similar to bone suitable for implantology exercises. Metal back plate with thread for screw retention or optional retention with magnet mounting plates in frasaco phantom heads



# implantology and full denture exercises

**B-3 NHB** bite block suitable for models B-3 NHJW and B-3 NH



**B-3 NHJO** these edentulous upper and lower jaw models correspond to the frasaco model B-3 NHJW, but without removable gingiva



**B-3 NHJ WOK** soft removable gingiva for the upper jaw of the edentulous model B-3 NHJW

**B-3 NHJ WUK** soft removable gingiva for the lower jaw of the edentulous model B-3 NHJW



**B-3 LMU** edentulous upper and lower model jaws, execution in hard thermo-setting plastic material, normal bite without undercuts. Upper jaw corresponding to B-3 NM (see page 49), however lower jaw with an exchangeable insert made from special material simulating human bone. Thanks to this combination the model can not only be used for full denture exercises in prosthodontics, but also for first implant training in material similar to human bone with correct anatomy. As the insert made from simulated bone material can be changed individually, an economical model combination for multiple usage

**B-3 NMB** bite block suitable for B-3 LMU

**B-3 UK LMU** edentulous lower jaw, execution in hard thermosetting plastic material, normal bite without undercuts with an exchangeable insert made from special material simulating human bone

**B-3 UK LMUE** insert made from special material simulating human bone fitting B-3 UK LMU model for repeated implantology training

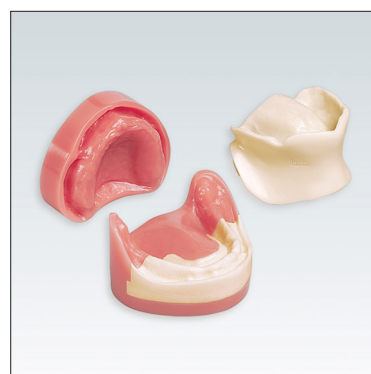

# implantology and full denture exercises



**ANA-4 TOKJ VG 901**

partially dentate solid-cast upper jaw made from material suitable for placing implants. Implants can be placed in edentulous areas to allow subsequent implant prosthetic treatment to be performed. Model holder MA-1 will also be required with this simple entry-level model for working in the phantom head



**ANA-4 TOKJ VG 902**

partially dentate solid-cast upper jaw made from material suitable for placing implants. Implant analogues (hex) have already been placed in the edentulous areas to allow training of implant prosthetic treatment. Model holder MA-1 will also be required with this simple entry-level model for working in the phantom head

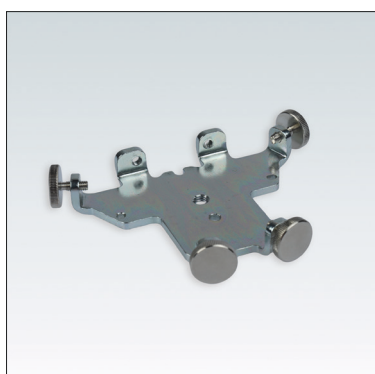

**MA-1**

using model holder MA-1 models, which do not have a back plate for retention in a phantom head, can be fixed with screws on the side and thus inserted in phantom heads. This allows simple models, such as the previously described models of the ANA-4 TOKJ VG series or in-house fabricated dental stone models to be adapted for use with phantom heads



**B-3 NH**

edentulous upper and lower model jaws, execution in hard thermosetting plastic material, normal bite without undercuts. Metal fixing plate with thread to be used for screw-in or magnetic fixation

**B-3 NHB**

bite block suitable for B-3 NH



**B-3 NHG**

rubber moulds for casting plaster duplicates of edentulous model B-3 NH, normal bite

**B-3 ZP**

transparent centric plate with four guidance pins, fixing screw and mounting thread M6 to be placed upon the rubber mould, models cast from rubber moulds can thus be screwed in frasaco phantom heads or articulators  
package containing 1 centric plate, 1 fixing screw, 5 mounting threads

**B-3 ZPB**

re-fill pack containing 10 mounting threads

# edentulous models for full denture exercises

**B-3 NM** edentulous upper and lower model jaws, execution in hard thermosetting plastic material, normal bite with undercuts. Metal fixing plate with thread to be used for screw-in or magnetic fixation

**B-3 NMB** bite block suitable for B-3 NM

**B-3 NMG** rubber moulds for casting plaster duplicates of edentulous model B-3 NM, normal bite, with undercuts

**B-3 ZP** transparent centric plate with four guidance pins, fixing screw and mounting thread M6 to be placed upon the rubber mould, models cast from rubber moulds can thus be screwed in frasco phantom heads or articulators  
package containing 1 centric plate, 1 fixing screw, 5 mounting threads

**B-3 ZPB** re-fill pack containing 10 mounting threads

**B-3 CSP** edentulous upper and lower jaws with natural anatomy as found in daily practice. The position of the lowest point of the alveolar ridge in the areas of the first permanent molars can be determined easily and precisely. Ideal for teaching essential, theoretical principles of setting denture teeth as well as for realistic impression taking. Size and shape perfectly fit the frasco standard model series ANA-4. Execution in hard thermosetting plastic material, metal fixing plate with thread, so it can be used for screw-in or magnetic fixation

**B-3 CSPB** bite block suitable for B-3 CSP

**B-3 CSP G** rubber moulds for casting plaster duplicates of edentulous model B-3 CSP, normal bite. This mould allows the making of plaster models using the metal fixing plates AN-4 ZPE

**AN-4 ZP** transparent centric plate with four guidance pins, fixing screw and metal fixing plate with mounting thread M6 to be placed upon the rubber mould

models cast from rubber moulds can thus be mounted in frasco phantom heads or articulators with screw-in or magnetic fixation  
package containing 1 centric plate, 1 fixing screw, 5 fixing plates  
re-fill pack containing 10 fixing plates

**B-3 KN** edentulous upper and lower model jaws, execution in hard thermosetting plastic material, cross bite with thread to be used for mounting to frasco phantom heads

**B-3 KNB** bite block suitable for B-3 KN

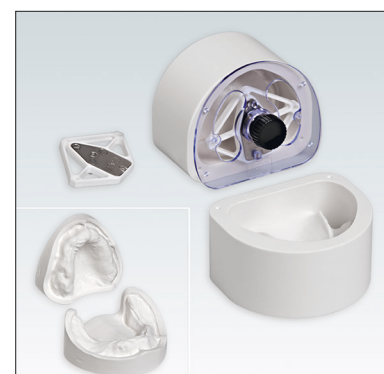

# models for dental technicians



## **B-3 D**

edentulous upper and lower model jaws, execution in hard thermosetting plastic material, close bite with thread to be used for mounting to frasaco phantom heads

## **B-3 DB**

bite block suitable for B-3 D



## **AG-3 G 28**

rubber moulds for dental technicians examinations, for casting completely dentate master models upper and lower model jaw moulds for 28 gnathologically contoured teeth in a stable intercuspitation with canine guidance and functional contact points

anterior relationship: deep overbite, initial anterior and canine guidance

Premolar to first molar region: tooth relationship = 1 : 2

Second and third molar region: tooth relationship = 1 : 1 distally



## **AG-3 ZP**

transparent centric plate with four guidance pins, fixing screw and mounting thread M6 to be placed upon the rubber mould models cast from rubber moulds can thus be screwed in frasaco phantom heads or articulators

package containing: 1 centric plate, 1 fixing screw, 5 mounting threads

the rubber moulds AG-3 G 28 are however not included in the AG-3 ZP set

## **AG-3 ZPB**

re-fill pack containing 10 mounting threads

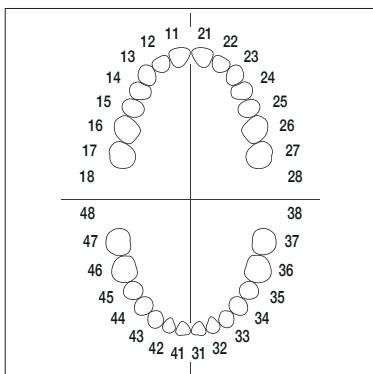

## **AG-3 Z 28**

set of 28 gnathologically shaped frasaco teeth for grinding, suitable for rubber negative mould AG-3 G 28, with screws

## **AG-3 ZE 010**

bag containing 10 individual model teeth of the same position to fit AG-3 models, with screws

## **AG-3 ZE 100**

bag containing 100 individual model teeth of the same position to fit AG-3 models, with screws



## **B-3 NT**

edentulous upper and lower model jaws, execution in hard thermosetting plastic material, with thread to be used for mounting to frasaco phantom heads, upper and lower model jaws perfectly matching each other, ideal distance between models to set up the teeth

## **B-3 NTB**

bite block suitable for B-3 NT

# dental hygiene training

**AG-3 H** oral hygiene model  
articulating upper and lower model jaws are occluding in a stable intercuspitation, (32 teeth with gnathological fissures, series AG-3 Z), hard thermosetting material, elastic removable gingivae, simulation of periodontosis with pockets, suitable for subgingival removal of calculus



**AG-3 H KR** oral hygiene model similar to AG-3 H, however with gingivae in red-transparent execution



**AG-3 WOKH** elastic removable gingiva for oral hygiene model upper jaw, held in place by the model teeth

**AG-3 WOKH KR** as above, however in red-transparent execution

**AG-3 WUKH** elastic removable gingiva for oral hygiene model lower jaw, held in place by the model teeth

**AG-3 WUKH KR** as above, however in red-transparent execution



**A-CK** synthetic calculus  
for application on roots and crowns of model teeth, roughening of the tooth surface is no longer needed before application of the synthetic calculus  
packing content is sufficient for approx. 1.800 model teeth

**Note: These products have been classified as hazardous goods and must be labeled and shipped in accordance with the relevant laws and regulations. This can make airfreight very costly. Please let us know in advance the exact quantities you require, so we can send you an offer detailing the additional cost.**



**AG-3 Z** set of 32 gnathologically contoured model teeth to fit AG-3 models, with screws

**AG-3 ZE 010** bag containing 10 individual model teeth of the same position to fit AG-3 models, with screws

**AG-3 ZE 100** bag containing 100 individual model teeth of the same position to fit AG-3 models, with screws

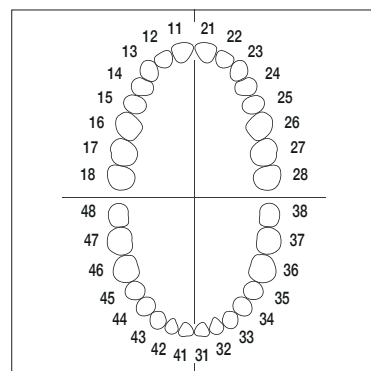



# periodontology model A-PZ



**A-PZ** periodontal model  
upper and lower model jaws with elastic removable gingivae  
simulation of periodontosis in its early to advanced stages



**A-PZ WOK** elastic removable gingiva for upper jaw A-PZ OK  
suitable for surgical exercises

**A-PZ WOK KR** as above, however in red-transparent execution

**A-PZ WUK** elastic removable gingiva for lower jaw for A-PZ UK  
suitable for surgical exercises

**A-PZ WUK KR** as above, however in red-transparent execution



**A-CK** synthetic calculus for application on roots and crowns of model teeth  
packing content is sufficient for approx. 1.800 model teeth

**Note:** These products have been classified as hazardous goods and must be labeled and shipped in accordance with the relevant laws and regulations. This can make airfreight very costly. Please let us know in advance the exact quantities you require, so we can send you an offer detailing the additional cost



**A-P K G** adhesive for gingivae



# teeth for periodontology model A-PZ

**A-PZ Z** set of 27 model teeth, execution in hard thermosetting plastic material, with screws, suitable for model A-PZ  
standard model teeth, as well as special teeth with 1 and 2 roots without calculus

**A-PZ ZC** set of 27 model teeth, with screws, suitable for model A-PZ with calculus

**A-PZ ZE** standard model teeth without calculus  
upper 11, 12, 13, 14, 15, 17  
upper 21, 22, 23, 24, 25  
lower 32, 37  
lower 42, 43

**A-PZ ZEC** standard model teeth, optional assortment with calculus

**A-PZ ZE 1** special model teeth with 1 root without calculus  
upper 26, 27  
lower 31, 33, 34  
lower 41, 44, 45

**A-PZ ZEC 1** special model teeth with 1 root, optional assortment with calculus

**A-PZ ZE 2** special model teeth with 2 roots without calculus  
upper 16  
lower 36  
lower 46, 47

**A-PZ ZEC 2** special model teeth with 2 roots, optional assortment with calculus

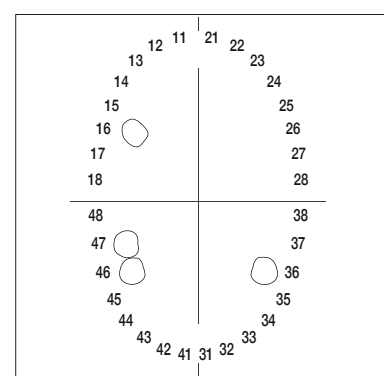
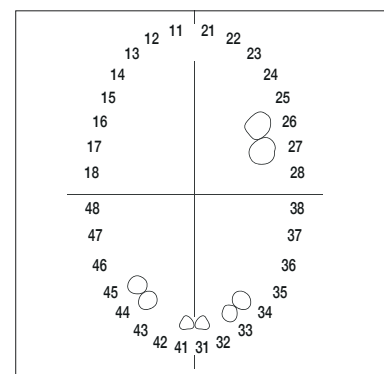
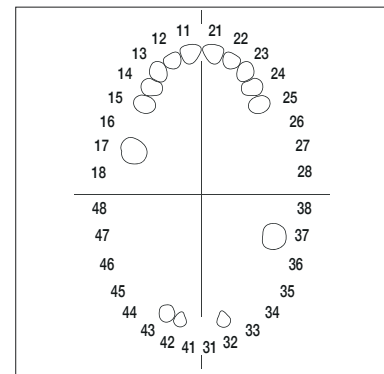

# periodontology model A-PB



**A-PB** periodontal model upper and lower model jaws with elastic removable gingivae  
simulation of well-advanced periodontosis of gingivae and maxillae bones



**A-PB WOK** elastic removable gingiva for upper jaw A-PB OK  
suitable for surgical exercises

**A-PB WOK KR** as above, however in red-transparent execution

**A-PB WUK** elastic removable gingiva for lower jaw A-PB UK  
suitable for surgical exercises

**A-PB WUK KR** as above, however in red-transparent execution



**A-CK** synthetic calculus for application on roots and crowns of model teeth  
packing content is sufficient for approx. 1.800 model teeth

**Note: These products have been classified as hazardous goods and must be labeled and shipped in accordance with the relevant laws and regulations. This can make airfreight very costly. Please let us know in advance the exact quantities you require, so we can send you an offer detailing the additional cost**



**A-P K G** adhesive for gingivae



**A-PB Z** set of 26 model teeth, in hard thermosetting plastic material with screws, suitable for model A-PB  
standard model teeth as well as special teeth with 1, 2 and 3 roots without calculus

**A-PB ZC** set of 26 model teeth, execution in hard thermosetting plastic material, with screws, suitable for model A-PB  
with calculus

# A-PB model teeth and peri-implantitis model

**A-PB ZE** standard model teeth  
without calculus  
upper 11, 13, 14, 15  
upper 21, 22, 25  
lower 32  
lower 42, 43

**A-PB ZEC** standard model teeth, optional assortment  
with calculus

**A-PB ZE 1** special model teeth with 1 root  
without calculus  
upper 23  
lower 31, 33, 34, 35  
lower 41, 44, 45, 47

**A-PB ZEC 1** special model teeth with 1 root, optional assortment  
with calculus

**A-PB ZE 2** special model teeth with 2 roots  
without calculus  
upper 24  
lower 36, 37

**A-PB ZEC 2** special model teeth with 2 roots, optional assortment  
with calculus

**A-PB ZE 3** special model teeth with 3 roots  
without calculus  
upper 16, 17  
upper 26, 27

**A-PB ZEC 3** special model teeth with 3 roots, optional assortment  
with calculus

**A-PB PI OK** the upper jaw model A-PB PI consists of a base made from material suitable for placing implants, and gingiva suitable for suturing. Implants can be placed at areas already marked with slight indents. The gingiva and the bone surrounding the implant have the characteristics of peri-implantitis, allowing simulation of treatment. For mounting in the phantom head the model holder MA-1 (page 48) is required.

**A-PB PI WOK** Removable gingiva for upper jaw model A-PB PI for peri-implantitis exercises

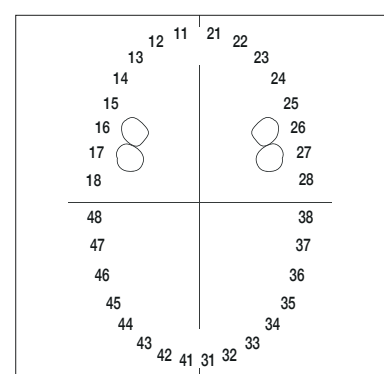
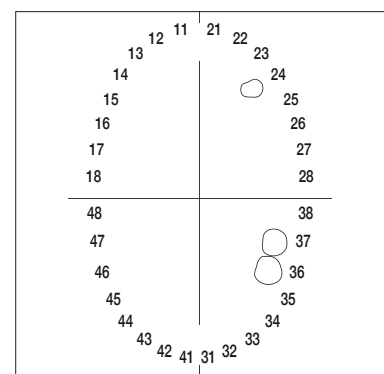
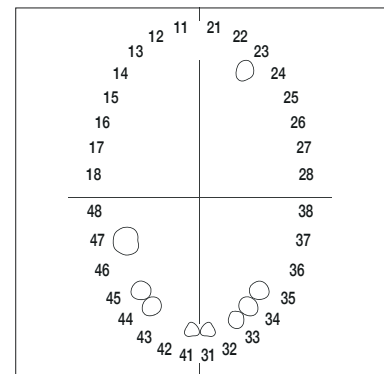
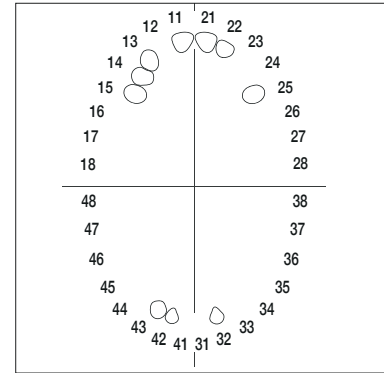

# x-ray diagnosis and local anaesthesia



**A-R**

x-ray model tray  
execution in transparent radiolucent plastic with slots for x-ray films, mounting thread for frasaco phantom heads, suitable for upper and lower jaws to hold extracted teeth (e.g. for diagnosis of approximal caries)

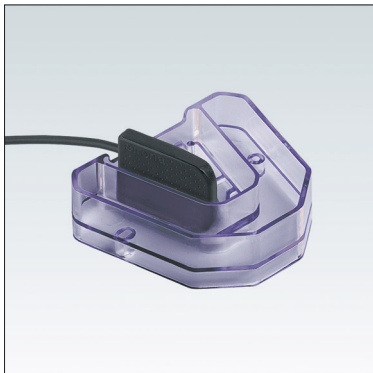

**A-RS**

x-ray model tray, execution in transparent radiolucent plastic similar to the model A-R, however with wider jaw arc, can be used with either x-ray films or CCD-sensors of various sizes. With its back plate the model can be used both in phantom heads with magnetic mounting plates and positioning pins or with standard mounting threads



**AG-3 IB**

dental model for local anaesthesia  
articulating upper and lower jaws (32 teeth in hard thermosetting material with gnathological fissures), integrated micro-electronic circuit  
3 contact points in the maxilla  
2 contact points in the mandible  
2 contact points in the raising branches of the lower jaw  
audio-signal after correct injection  
elastic removable gingivae  
injection model with battery

**Note: Always use a dry syringe only with this model, i.e. without anaesthetic, to avoid damaging the integrated contact points.**

**7098**

spare battery for injection model AG-3 IB



**AG-3 I WOK**

elastic, removable gingiva for upper jaw

**AG-3 I WUK**

elastic, removable gingiva for lower jaw

**AG-3 I WS**

elastic removable gingiva for raising branches of lower jaw



**AK-6/2 IB**

anaesthesia training model for pediatric dentistry  
Upper and lower jaw like pedodontal model AK-6/2 with 20 deciduous teeth and 4 permanent molars, execution in hard thermosetting plastic material with elastic removable gingivae and integrated micro-electronic. 8 contact points in the upper jaw, 5 contact points in the lower jaw and 2 contact points in its raising branches for training infiltration and intra-ligamentous techniques of anaesthesia.  
Audio signal after correct injection.  
Syringe included in the kit.

**Note: Accessories for this model can be found on page 66**

# exodontic exercises

**A-E M** extraction model for basic exercises  
 execution in cast aluminium, 32 metal teeth in CrNi-Steel,  
 embedded in resistant plastic resin, with back plate



**A-E ZM** set of 32 metallic model teeth in CrNi-Steel for extraction  
 model A-E M

**A-E ZME** individual metallic model teeth in CrNi-Steel  
 optional assortment

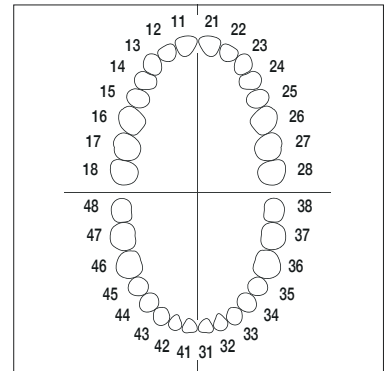

**A-E K** extraction model for advanced exercises  
 execution in cast aluminium, 32 plastic teeth  
 embedded in resistant plastic resin, with back plate

plastic teeth roots will fracture in case of incorrect luxation



**A-E ZK** set of 32 plastic model teeth in hard thermosetting material,  
 for extraction model A-E K

**A-E ZKE** individual plastic model teeth in hard thermosetting material,  
 optional assortment

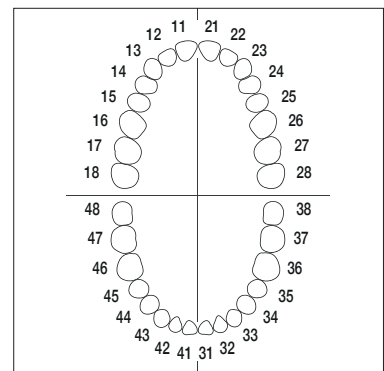

**A-E MK** extraction model, execution in cast aluminium, 16 model teeth in  
 CrNi-Steel and 16 plastic teeth, embedded in resistant plastic resin,  
 with back plate



# exodontic exercises



**A-E G**

rubber mould for upper and lower model jaws  
suitable for reconstruction of model A-E

detailed information upon request



**A-E F**

plastic model material and catalyst for reconstruction of extraction  
model jaws, requirement approx. 50 g plastic model material and  
17,5 g catalyst per model, contents of package:  
500 g plastic model material  
175 g catalyst

**A-E Q**

sufficient for approx. 10 models (upper and lower jaw)  
separating spray for repeat application,  
sufficient for approx. 50 applications

**Note: These products have been classified as hazardous goods and must be labeled and shipped in accordance with the relevant laws and regulations. This can make airfreight very costly. Please let us know in advance the exact quantities you require, so we can send you an offer detailing the additional cost.**



**A-E ROK**

back plate for upper jaw for positioning of root apices

**A-E RUK**

back plate for lower jaw for positioning of root apices



**A-E AOK**

upper jaw aluminium base for extraction model for mounting the  
upper teeth, with mounting thread for frasaco phantom heads

**A-E AUK**

lower jaw aluminium base for extraction model for mounting the  
lower teeth, with mounting thread for frasaco phantom heads



# oral surgery

**A-J OP OK** surgical training model, upper jaw (can be reconstructed and reused again) with vestibular and palatal impacted canines and partial dentition, some teeth with apex areas affected by granuloma. 11, 12, 14, 16 and 21, 22, 24 and 26 with granuloma prepared for apicectomy. 21 with transparent root for root filling control the elastic removable gingiva allows for realistic surgical exercise and suturing  
\*demo model shown not available



**A-J A** model mounting plate for phantom head needed for model A-J OP UK

**A-J OP UK** surgical training model (can be reconstructed and reused again) anatomical designed mandible in special plastic material similar to human bone, simulated nerves left and right at different locations, exchangeable teeth no. 31, 32, 33, 34, 37 with granuloma prepared for apicectomy. The completely impacted and partially rotated wisdom teeth are prepared for surgical extraction (Alveole 33 with bone pocket and fenestration, suitable for GTR-application). The elastic removable gingiva allows for realistic surgical exercises and suturing  
\*demo model shown not available

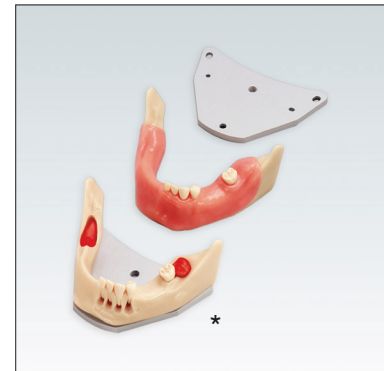

**A-J OP WOK** soft removable gingiva for upper jaw, suitable for A-J OP OK

**A-J OP WUK** soft removable gingiva for lower jaw, suitable for A-J OP UK



**A-J OP ZE** individual teeth for replacement for models A-J OP:  
upper 11, 12, 14, 16 teeth with root for resection  
upper 13 tooth with root for embedding  
upper 21 tooth with root for resection  
upper 22, 24, 26 teeth with root for resection  
upper 23 tooth with root for embedding  
lower 31, 32, 33, 34, 37, 38 teeth with root resection  
lower 48 tooth with root for embedding

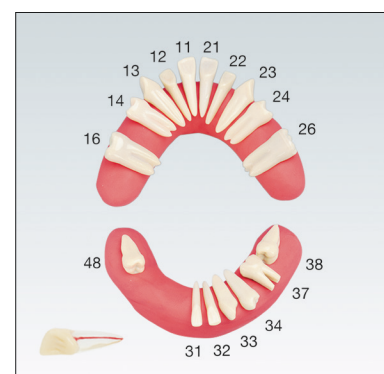

**A-J OP ZET** upper 21 transparent tooth with root and complete root canal for endo-surgical training

**A-J OP OK K** synthetic resin with a consistency similar to bone for embedding teeth into upper jaw A-J OP OK

**A-J OP UK K** synthetic resin with a consistency similar to bone for embedding teeth into lower jaw A-J OP UK

**Note: These products have been classified as hazardous goods and must be labeled and shipped in accordance with the relevant laws and regulations. This can make airfreight very costly. Please let us know in advance the exact quantities you require, so we can send you an offer detailing the additional cost.**



# oral surgery



**A-OP OK**

surgical model, upper model jaw  
with displaced canine 23  
resection openings around the central incisor 11 and premolar 24  
all teeth with exception of 23 are screwed-in and can be replaced  
soft removable gingiva for surgical exercises



**A-OP UK**

surgical model, lower model jaw  
with displaced wisdom tooth 38  
resection opening around the canine 33,  
all teeth with exception of 38 are screwed-in and can be replaced  
soft removable gingiva for surgical exercises



**A-OP WOK**

soft removable gingiva for upper jaw to be adhered to A-OP OK models

**A-OP WUK**

soft removable gingiva for lower jaw to be adhered to A-OP UK models

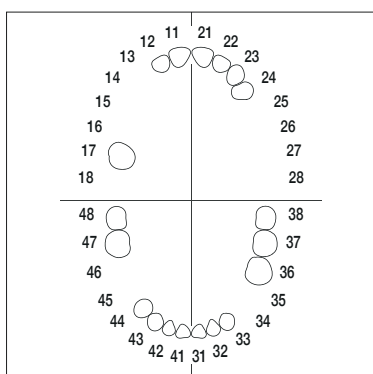

**A-OP ZE**

individual model teeth with screws, optional assortment  
(A-3 ZE anatomy)

- upper 11 tooth with root for resection,
- upper 12, 17, 21, 22
- upper 23 tooth with root for embedding
- upper 24 tooth with root for resection
- lower 31, 32, 36, 37
- lower 33 tooth with root for resection
- lower 38 tooth with root for embedding
- lower 41, 42, 43, 44, 47, 48



**A-OP KN**

synthetic resin with a consistency similar to bone for embedding canine and wisdom tooth  
consisting of 4 bottles plus 1 strip of wax  
sufficient for 3 dental models

**Note:** These products have been classified as hazardous goods and must be labeled and shipped in accordance with the relevant laws and regulations. This can make airfreight very costly. Please let us know in advance the exact quantities you require, so we can send you an offer detailing the additional cost.

frasaco

# deciduous model



**AM-5**

deciduous denture model, articulating upper and lower model jaws, execution in elastic transparent plastic, 20 friction-fit teeth made from hard thermosetting material anatomically formed roots



**AM-5 99-001**

deciduous denture model AM-5 with model mounting plates AM-SRM for screw-in or magnetic fixation in frasaco phantom heads

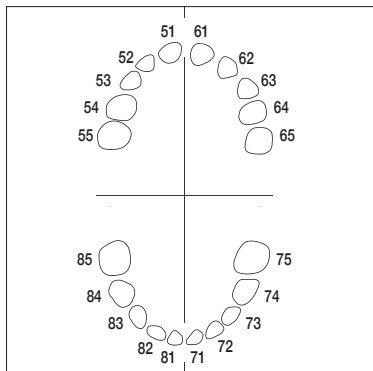

**AM-5 Z**

set of 20 friction-fit deciduous model teeth with anatomically formed roots to fit AM-5 models

**AM-5 ZE**

individual friction-fit deciduous model teeth optional assortment



**AM-SRM**

mounting plates AM-SRM for screw-in or magnetic fixation of AM-5 in frasaco phantom heads

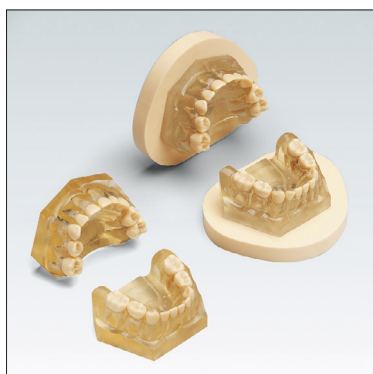

**AM-5 E A**

extraction model for pediatric dentistry with model mounting plates AM-SRM for screw-in or magnetic fixation in frasaco phantom heads

**AM-5 E**

extraction model for pediatric dentistry  
This version of our deciduous denture model AM-5 is made from a tough, but elastic heavy-duty plastic material allowing multiple exercises of pedo tooth extractions under constant and realistic conditions

# pedodontal models

**AK-6/2** mixed dentition model, upper and lower model jaws occlude in a stable intercuspitation, 20 deciduous teeth and 4 permanent molars. The deciduous anterior teeth in the lower jaw are friction-fit, all other teeth are screw retained. Execution in hard thermosetting plastic material, elastic removable gingivae, quick-release devices for model mounting plate

**AK-6/2 M** same as AK-6/2, however only with 20 deciduous teeth

**Note: These pedodontal models require model mounting plates AK-SRM when used in frasco phantom heads**

**AK-6/2 WOK** elastic removable gingiva for upper jaw, positioned over the model base, held in place by the model teeth, suitable for model AK-6/2 OK

**AK-6/2 WOKM** elastic removable gingiva for AK-6/2 M OK

**AK-6/2 WUK** elastic removable gingiva for lower jaw, positioned over the model base, held in place by the model teeth, suitable for model AK-6/2 UK

**AK-6/2 WUKM** elastic removable gingiva for AK-6/2 M UK

**AK-SRM** quick-release mounting plates for screw-in or magnetic fixation of pediatric models AK-6/2 and AK-6 in frasco phantom heads

**AK-6** mixed dentition model, to a large extent corresponding to AK-6/2. To facilitate first preparation exercises this version has a lower gingival contour. Therefore the teeth are easier accessible than the teeth of AK-6/2

**AK-6 M** same as AK-6, however only with 20 deciduous teeth

**Note: These pedodontal models require model mounting plates AK-SRM when used in frasco phantom heads**

**AK-6 WOK** elastic removable gingiva for upper jaw, positioned over the model base, held in place by the model teeth, suitable for model AK-6 OK

**AK-6 WOKM** elastic removable gingiva for AK-6 M OK

**AK-6 WUK** elastic removable gingiva for lower jaw, positioned over the model base, held in place by the model teeth, suitable for model AK-6 UK

**AK-6 WUKM** elastic removable gingiva for AK-6 M UK



# pedodontal models



**AK-6/2 DAK**

frasaco pedodontal model AK-6/2 with demonstration articulator DAK allowing simple functional movements

**AK-6 DAK**

frasaco pedodontal model AK-6 with demonstration articulator DAK allowing simple functional movements

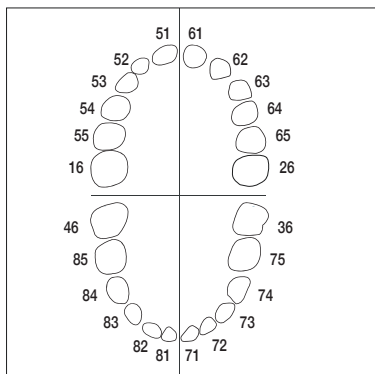

**AK-6/2 Z**

set of 20 deciduous model teeth and 4 permanent molars in hard thermosetting material with screws, for AK-6/2 models

**AK-6/2 ZE**

individual deciduous model teeth and permanent molars in hard thermosetting material with screws, optional assortment

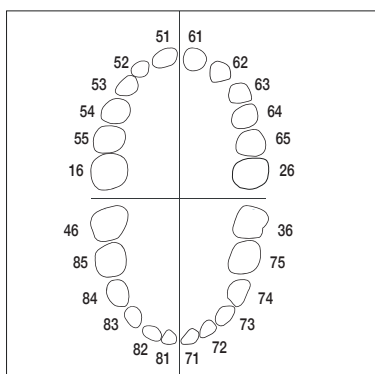

**AK-6 Z**

set of 20 deciduous model teeth and 4 permanent molars in hard thermosetting material with screws, for AK-6 models

**AK-6 ZE**

individual deciduous model teeth and permanent molars in hard thermosetting material with screws, optional assortment



**AK-6/2 ZP51  
99-002  
AK-6/2 ZP61  
99-002**

dental trauma:  
fractured teeth 51 and 61 can be treated with the aid of frasaco pedodontal strip crowns size 512 and 611A



**AK-6/2 ZP51  
99-003  
AK-6/2 ZP61  
99-003**

NBS Karies:  
teeth 51 and 61 show the destruction of the tooth substance with NBS caries. They can be treated with the aid of frasaco pedodontal strip crowns size 512 and 611A



# model teeth for pedodontal models

**AK-6/2 ZPU** deciduous model teeth with screws, red pulp inserts showing if approached too closely during preparation, execution in hard thermosetting material, fitting dental models AK-6/2 and AK-6  
 upper 53, 54, 55  
 lower 85



**AK-6/2 ZPUL** deciduous model teeth with screws, hollow pulp chamber for pulpotomy exercises, fitting dental models AK-6/2 and AK-6  
 upper 53, 54, 55  
 lower 85



**AK-6/2 ZPUW** deciduous model teeth with screws, pulp chamber filled with red wax for pulpotomy exercises e.g. with a spoon-excavator, fitting dental models AK-6/2 and AK-6  
 upper 53, 54, 55  
 lower 85

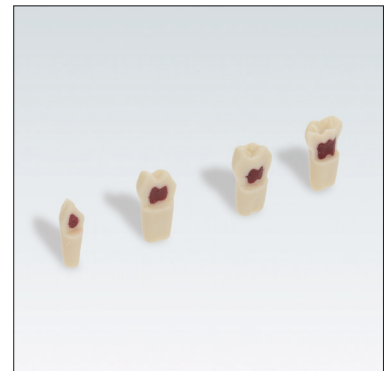

**AK-6/2 ZPUWPK** deciduous teeth according to AK-6/2 ZPUW, pulp cavity filled with red wax, additional caries lesions suitable for models AK-6/2 and AK-6  
 upper 53, 54, 55  
 lower 85

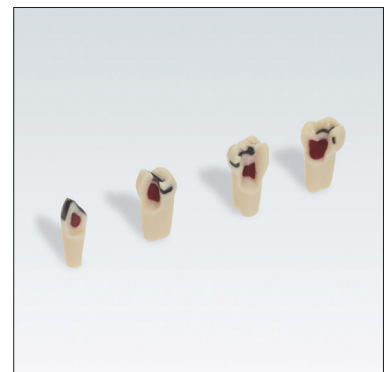

**AK-6/2 ZPUF** model teeth for deciduous teeth endodontics suitable for model bases AK-6/2 and AK-6, screw retention, with transparent root and red hollow root canals, and ivory-coloured crowns made from Duroplast for pulpotomy exercises  
 upper 53, 54, 55  
 lower 85

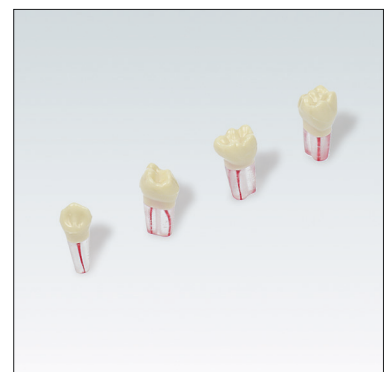

# training model for pediatric anaesthesia



## AK-6/2 IB

anaesthesia training model for pediatric dentistry  
Upper and lower jaw like pedodontal model AK-6/2 with 20 deciduous teeth and 4 permanent molars, execution in hard thermosetting plastic material with elastic removable gingivae and integrated micro-electronic. 8 contact points in the upper jaw, 5 contact points in the lower jaw and 2 contact points in its raising branches for training infiltration and intra-ligamentous techniques of anaesthesia.  
Audio signal after correct injection.  
Syringe included in the kit.



## AK-6/2 WOK

elastic, removable gingiva for upper jaw

## AK-6/2 WUK

elastic, removable gingiva for lower jaw

## AK-6/2 I WS

elastic removable gingiva for raising branches of lower jaw



## AK-SRM

quick-release mounting plates for screw-in or magnetic fixation of pediatric anaesthesia model AK-6/2 IB in frasaco phantom heads



## AK-6/2 IB HA

set consisting of pediatric anaesthesia training model AK-6/2 IB, mounting plates AK-SRM and model holder HA

## D-16

support, which can be used together with set AK-6/2 IB HA as a complete injection training system

## 7098

battery for pediatric anaesthesia training model

## AK-6/2 IS

syringe for pediatric anaesthesia training model

### Note:

**Always use a dry syringe only with this model, i.e. without anaesthetic, to avoid damaging the integrated contact points.**

# orthodontic exercises

**A-S** upper and lower metallic model jaw bases for casting individual study models with extracted teeth or frasaco teeth

**A-S G** rubber moulds to set up 28 teeth in A-S model jaw bases



**A-8** orthodontic denture model with 8 anterior teeth, as well as 24 (series A-3 ZEB) teeth supplied loose for embedding in dental wax, all teeth in hard thermosetting material, suitable to bond brackets, lateral incisors and canines fixed to support orthodontic bands

after fixation of brackets and orthodontic bands head the model should be removed and warmed up to melt the wax, teeth will move into the desired therapeutic position

(see exemplary right figure)



wax-mount model teeth for bracket exercises  
the roughened surface allows brackets to be fixed using commercial epoxy resin adhesive (brackets not included)

**A-3 ZEB** individual teeth series A-3 ZEB for dental model A-8, 24 teeth available including A-3 K

**A-S ZEB** individual teeth series A-S ZEB for dental model A-S, 28 teeth available

**A-3 K** these apical retention beads prevent teeth extrusion from the wax base (already contained in A-3 ZEB and A-S ZEB)

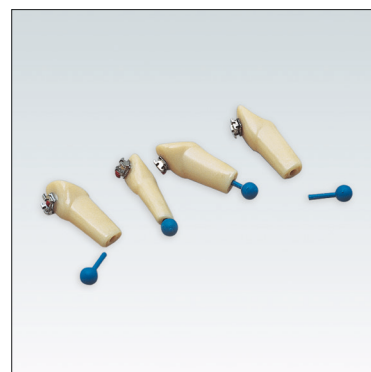

**A-R** model tray  
execution in transparent plastic for embedding extracted teeth in dental wax, mounting thread for frasaco phantom heads, suitable for upper and lower jaws. After fixation of brackets and orthodontic bands the model should be removed and warmed up to melt the wax and teeth will move back to the correct position)



# demonstration models



**D-1**

mandible in natural size with various pathological changes, hinged jawbone segment opens to show the nerve system, the roots, a suppurative pulp infection, a displaced wisdom tooth, caries, calculus and a sagittal section through crown and roots of tooth 44



**D-2**

individual model tooth, scale 5:1, 28 teeth available please specify tooth position required when ordering

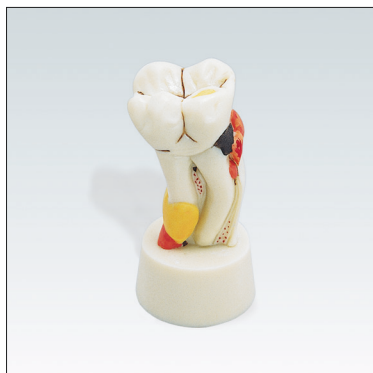

**D-15**

molar socket model scale 5 : 1  
lateral exposure showing caries, calculus, abscess, abrasion and suppuration



**D-4**

caries demonstration model  
scale 5 : 1  
with 3 removable and sectionable teeth  
showing 3 stages of caries and pulp affection

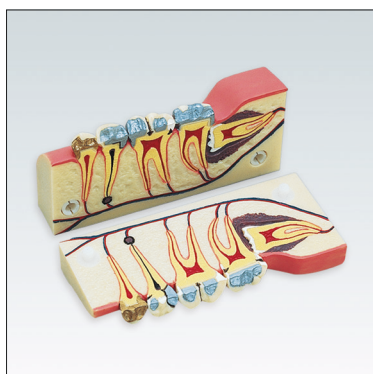

**D-5**

sectioned molar demonstration model  
scale 2.5 : 1  
showing the nerve system, the roots, a crown with inlay, an amalgam filling, an abscess and a displaced wisdom tooth with signs of dissociation by inflammation

# demonstration models

**D-6 KF** demonstration model to teach waxing-up techniques on occlusal surfaces as well as morphology and function of anatomical teeth, distinguished by its three point intercuspitation, ideal for optimum waxing-up of the occlusals

upper and lower model jaws scale 5 : 1, tooth and gingiva coloured plastic with individual contact points



**A-3 DAD 16** dental model A-3 DA with support (right)

**AG-3 DAD 16** dental model AG-3 DA with support (left)

**D-16** support



**ANA-4 DAFD 16** dental model ANA-4 DAF with support (right)

**AK-6/2 DAKD 16** deciduous dental model AK-6/2 DAK with support (left)

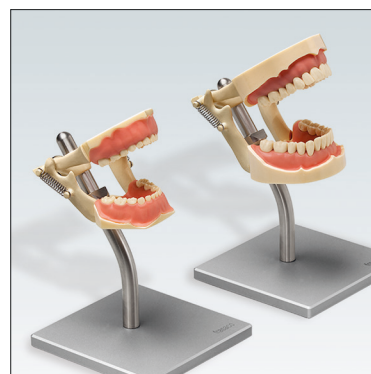

**AK-6/2 DAK** combined with a demonstration articulator DAK the deciduous denture model AK-6/2 is a useful tool for explaining topics of pediatric dentistry like temporomandibular articulation, grinding of teeth etc. to the patient



frasaco





## phantom heads modular dental training systems

frasaco phantom heads permit the simulation of life-like situations from all fields of dental surgery and dental technology without distracting attention from the essentials.

Our pride in innovation and decades of experience have been directed towards simplifying use, reducing the number of individual components and minimizing maintenance. The result is as simple as it is precise and economical. All units have been designed along modular construction lines.

Every workstation can be assembled according to the topic being taught, and extended, if necessary. Our units are always as simple or, as complex, as necessary.

# characteristics of our phantom heads

The frasaco phantom head is the ideal working tool for under and postgraduate courses for demonstrations and practical exercises. The state-of-the-art teaching system to simulate clinical cases in a realistic environment. For universities and institutions, but also for the dental office. A space saving dental simulator to train dental procedures to perfection. At any time.

All materials used such as aluminium, refined steel, thermoplastics and elastomers are of high-grade quality. The aluminium components have a coating which provides extra protection against corrosion and facilitates cleaning, in order to prevent any scratches becoming visible, thus allowing the components to longer retain their aesthetic appearance.

Many years of experience in manufacturing phantom heads, have long proven its high quality. The robust construction has been proven in daily practice, designed for use by students: practical to use and featuring uncomplicated handling as well as concentrating on the essential functions.

The patented frasaco articulation (P-6 and PK-2 series) combines average values of protrusive, mediotrusive and laterotrusive paths in one. Optimum functioning using few parts, warrants for reduced maintenance and repairs as all screws are locked into place and cannot be lost. Clearly contoured components allow for easy cleaning. Inaccessible areas which could trap dirt have been avoided.

The modular construction of the frasaco model range perfectly fits the frasaco phantom heads. Spare parts availability is assured for up to 10 years.



# frasaco phantom heads P-6/3

## Example for ordering a complete frasaco phantom head

Phantom head	1 frasaco phantom head P-6/3
Mask	1 frasaco face mask P-6 GMN 1L
Water drainage	1 frasaco water drainage system P-6 WFS1
Model	1 upper and lower model jaws frasaco AG-3
Mounting	1 frasaco table mounting assembly P-TDGP

### P-6/3

frasaco phantom head P-6 with exchangeable articulator P-3

The articulator P-3 has anatomically shaped condyle boxes to allow for simulation of corresponding human masticatory functions within three-dimensional curved condylar paths. The model jaws and articulations are positioned in the correct anatomical relationship and the natural excursions of the mandible can be exactly reproduced. The vertical adjustment allows for mounting of different model jaws. The robust skull dome is coloured throughout in grey with a plastic coat of approx. 3 mm thickness, to prevent paint to splinter off and to allow scratches to be polished out. The neck articulation is located in the anatomically correct position at the cranial base and is used to position the head. The robust lift inside the skull dome provides access to a star knob which releases the face mask holding plate.

In order to allow anatomical face bows to be mounted, a nose has been added to the skull dome and the articulator P-3 is provided with corresponding fixing pins. Should the mandible be opened to 15 mm distance between upper and lower incisal edges, a deflection roller makes the heads of the condyles slide forward as with a patient. All components are made of high-grade materials and all fixing bolts are protected against loss. A face mask can be gripped between the liftplate and the articulator plate (dental model and fixation not included)



**frasaco phantom heads are always equipped for screw retention of dental models. If you would prefer the models to be retained magnetically, magnet mounting plates can also be incorporated (no extra charge). Please inform us accordingly.**

### P-6/3 HGB

The phantom head P-6/3 HGB (with limitation of the neck according to the anatomical degrees of freedom) is being used instead of the above mentioned P-6/3 with all frasaco training systems that include a shoulder torso

### P-6/3 PRO

P-6/3 PRO is a special version of the proven frasaco P-6/3 phantom head, which has been optimized and adapted to the specific needs of education in prosthodontics

The incisal distance has been increased from approx. 42 to 52 mm with gliding condyle paths. An incisal pin is included for exercises with edentulous models. 2 additional pressure pins have been added to the condyle boxes. With these centric locks the centric position of the condyles can be determined and set with precision. All other features are exactly corresponding to P-6/3, so that the same accessories can be used and all combinations with mounting systems etc. are possible as with P-6/3



### P-6/3 PRO HGB

The phantom head P-6/3 PRO HGB (with limitation of the neck according to the anatomical degrees of freedom) is being used instead of the above mentioned P-6/3 PRO with all frasaco training systems that include a shoulder torso

# frasaco phantom heads P-6/3, P-6/5 and accessories

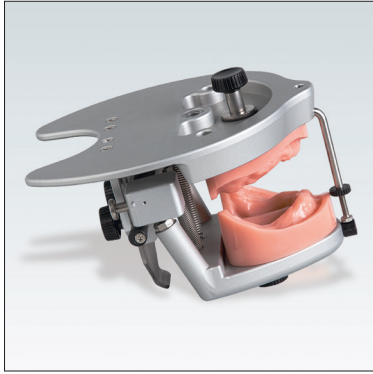

**P-6/3 EINSATZ PRO**

P-6/3 EINSATZ PRO can be ordered for upgrading existing P-6/3 heads by replacing the standard P-3 articulator. It is a special version of P-3, which has been optimized and adapted to the specific needs of education in prosthodontics

The incisal distance has been increased from approx. 42 to 52mm with gliding condyle paths. An incisal pin is included for exercises with edentulous models. 2 additional pressure pins have been added to the condyle boxes. With these centric locks the centric position of the condyles can be determined and set with precision. All other features are exactly corresponding to P-3, so that the same accessories can be used (dental model not included)



**P-6/5**

The P-6/5 phantom head is the most sophisticated training aid, description corresponding to P-6/3 including the following additional features: the inclination of condylar guidance is adjustable on both sides thus allowing the ideal anterior and canine guidance or a fully balanced occlusion to be simulated. The basic geometric dimensions can be measured and the models can be transferred to partial and fully adjustable articulators. A nose has been added to the skull dome and the articulator is provided with corresponding fixing pins at the hinge-axis points for mounting of anatomical face bows and hinge-axis localizers

(dental model and fixation not included)

**frasaco phantom heads are always equipped for screw retention of dental models. If you would prefer the models to be retained magnetically, magnet mounting plates can also be incorporated (no extra charge). Please inform us accordingly.**

**P-6/5 HGB**

The phantom head P-6/5 HGB (with limitation of the neck according to the anatomical degrees of freedom) is being used instead of the above mentioned P-6/5 with all frasaco training systems that include a shoulder torso

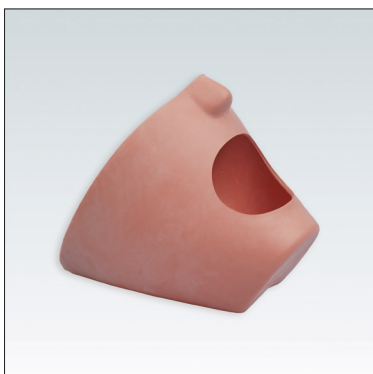

**P-6 GMN**

The new P-6 GMN face mask is the new standard for frasaco phantom heads and replaces the previous version P-6 GM. The mask combines the familiar resistant material with a realistic but slightly wider mouth shape than previously



**P-6 GL**

The P-6 GL face mask has a slightly larger vertical mouth opening, for example as required for DentSim type simulators

**P-G**

The face mask P-G with widened mouth opening and extended chin shape was specially developed for the P-6/3 PRO phantom heads, as well as for use with the integrated type P-G IWS suction hose. The modified design reduces the tensile load in the oral region of the mask

# accessories for frasaco phantom heads

**P-6 W** water drainage nozzle for face masks  
The positions for connecting the water drainage nozzle are marked on the inside of the face mask and can easily be perforated



**P-6 SL** water drainage hose (1,20 m)

**P-6 K** snap-on coupling for water hose incl. water drainage hose P-6 SK (0,12 m)

**P-6 H** support for water collector bottle

**P-6 F** water collector bottle



**P-6 GMN1L** face mask of the series P-6 GMN with one hole in the bottom back region for connecting to a single water drainage system P-6 WFS 1

**P-6 WFS 1** This single water drainage system set includes a water drainage nozzle P-6 W, a water drainage hose P-6 SL, a snap-on coupling P-6 K including a short hose P-6 SK as well as a water collector bottle P-6 F, which can be mounted with a support P-6 H to a workstation



**P-6 GMN2L** face mask of the series P-6 GMN with two holes in the top back region for connecting to a dual water drainage system P-6 WFS 2

**P-6 WFS 2** This dual water drainage system set includes two water drainage nozzles P-6 W, two short water drainage hoses P-SK, a y-shaped adapter 1585, a water drainage hose P-6 SL, a snap-on coupling P-6 K including another short water drainage hose P-6 SK as well as a water collector bottle P-6 F, which can be mounted with a support P-6 H to a workstation.

We recommend P-6 WFS 2 specially for phantom heads with torso, as water can be drained during typical treatment positions from the lowest point

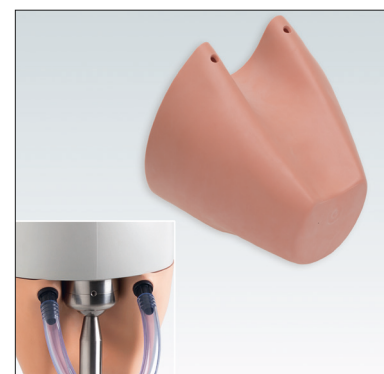

**P-G IW** face mask P-G with integrated suction hose inside the oral cavity, to be connected to a suction unit at the dental simulator

**P-G IWS** water suction hose set as repeat order part for face mask as above or for upgrading face mask P-G to a P-G IW



# accessories for frasaco phantom heads



**P-6 O**

ears for phantom head  
for all phantom heads also for completion.  
Anatomically correct designed ears made of hard plastic which can be fixed to the face mask with connectors included in the set.  
Anatomically correct and fixed position at the condyle boxes of the phantom head. Exercises with face bows can be done under realistic conditions. Supplied per pair

**P-6 A**

eyes for phantom heads (stickers), supplied per pair

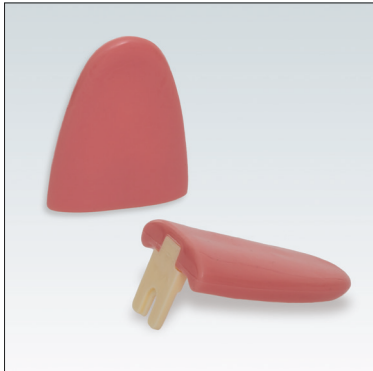

**P-Z**

removable elastic tongue  
The tongue is fixed to the model with a screw. To retrofit existing models, the tongue must be adhered to the model.  
We recommend the adhesive A-P K G.



**1260**

standard model mounting plates for fixing dental models with thread in frasaco phantom heads

**1260K OK**

upper jaw model mounting plate with positioning pins for fixing dental models with thread in frasaco phantom heads. The positioning pins allow for interchanging of model jaws in reproducible position

**1260K UK**

lower jaw model mounting plate with positioning pins for fixing dental models with thread in frasaco phantom heads. The positioning pins allow for interchanging of model jaws in reproducible position

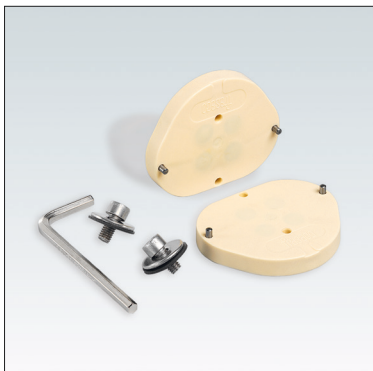

**1260M**

set of magnetic model mounting plates for frasaco phantom heads. The positioning pins (situated on the left and right side of the plates) allow for rapid interchanging of model jaws in reproducible position

**1260MJ**

set of magnetic model mounting plates for frasaco phantom heads like 1260M. The positioning pins are however situated at the front and rear of the plates.



**EL-1**

The calibration device EL-1 can be used in all phantom heads P-6/3 (PRO), P-6/5 and PK-2 and their variants. It makes sense to use magnetic recording plates as shown above. EL-1 corresponds to the dimensions of the frasaco standard model series ANA-4. Thus, for example, all phantom articulators in the classroom can be adjusted reliably and quickly to exactly the same position before tests.



# frasaco phantom heads PK-1 and PK-2

## PK-2

The frasaco phantom head PK-2 has been designed for users who are looking for a less expensive alternative to the proven P-6 series, without accepting compromises in handling and possible applications. With its neck articulation in the anatomically correct position at the cranial base and in combination with one of the many mounting systems frasaco can offer, it allows working in realistic treatment positions on workbenches, dental chairs or simulators. All face mask- and water drainage options frasaco offers for its series P-6 phantom heads can be used here too, so working with water is made easy. The phantom articulator of PK-2 features a temporomandibular joint with patented condylar boxes made from hard plastic with three-dimensional curved condylar paths for simulating anatomically correct jaw movements. The model jaws and articulations are positioned in the correct anatomical relationship and the natural excursions of the mandible can be exactly reproduced. The vertical adjustment allows for mounting of different model jaws. All versions of model mounting solutions well-known from the P-6 series can be used, including anatomical face bows.

The front part of the skull dome can be pulled open, as shown in the picture, for easy access to the screws for mounting dental models and face masks.

(dental model and fixation not included)

## PK-2 HGB

The phantom head PK-2 HGB (with limitation of the neck according to the anatomical degrees of freedom) is being used instead of the above mentioned PK-2 with all frasaco training systems that include a shoulder torso

**Note: The range of accessories as shown on pages 74 – 76 for series P-6 can also be used for series PK-1 and PK-2.**

## PK-1

The frasaco phantom head PK-1 has been designed for users who are looking for an inexpensive, however complete phantom head option with correct anatomical dimensions. With its neck articulation in the anatomically correct position at the cranial base and in combination with one of the many mounting systems frasaco can offer, it allows working in realistic treatment positions on workbenches, dental chairs or simulators. All face mask- and water drainage options frasaco offers for its series P-6 phantom heads can be used here too, so working with water is made easy. PK-1 does not have an articulator. All dental models that come with an M6 thread (except AG-3 IB) can be mounted using the adjustable frasaco universal articulator UAV, or use dental models with fixed demonstration articulators style DA, DAF, DAV or DAK with a short rod with a snap-in stopper to assure a stable fixation of the model during "treatment". The front part of the skull dome can be pulled open, as shown in the picture, for easy access to the screws for mounting dental models and face masks.

(dental model and fixation not included)

## PK-1 HGB

The phantom head PK-1 HGB (with limitation of the neck according to the anatomical degrees of freedom) is being used instead of the above mentioned PK-1 with all frasaco training systems that include a shoulder torso



**frasaco phantom heads are always equipped for screw retention of dental models. If you would prefer the models to be retained magnetically, magnet mounting plates can also be incorporated (no extra charge). Please inform us accordingly.**



# accessories for frasaco phantom heads PK-1 and PK-2

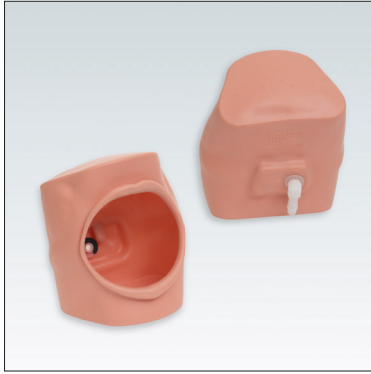

## P-6 GF

The frasaco oral cavity mask can either be used instead of the standard face mask with phantom heads series P-6 and PK or additionally as an inner face mask.

It does completely enclose the model jaws and therefore does allow working with water spray and making simulation exercises with limited space and realistic elasticity.

A useful side effect when using the mask in a phantom head is that the phantom head articulator is always kept clean.

(water drainage nozzle not included)

## P-6 WI

water drainage nozzle for oral cavity mask P-6 GF fitting to P-6 ISL hose with small diameter



## UAV

The frasaco universal articulator UAV made from hard thermosetting plastic material with patented adjustable mandible allows the usage of all dental models in stable occlusion (except AG-3 IB). Included is a short rod with a snap-in stopper to assure a stable fixation of the model during „treatment“

in addition to its usage in the PK-1 phantom heads the frasaco UAV universal articulator can also be used for working in the hand or screwed to existing phantom head fixation rods with a diameter of smaller or equal to 13 mm



## PK-1 P-BS

PK-1 P-BS is an alternative to screw fastening dental models with a thread M6 to a mounting plate of the phantom head. It comes with an attachment pole with snap-in stopper, so frasaco models with demonstration articulators DA, DAF, DAV, DAK or UAV can easily be mounted using their large fixing screw. All models with demonstration articulators that fit a 13 mm rod diameter can be mounted

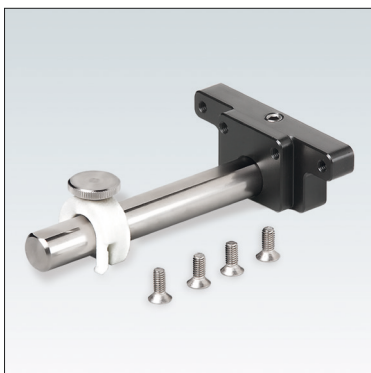

## P-BS

attachment pole fitting frasaco phantom heads PK-1.

Can be retrofitted. The screw holes necessary for fixation are already in place on the PK-1 series of phantom heads



## P-HA

The phantom head holder P-HA can be used to easily fasten model jaws without demonstration articulator in a phantom head PK-1

P-HA is especially recommended for the local anaesthesia training model AG-3 IB, which cannot be mounted to the hard plastic articulator series due to its raising branches of the lower jaw

# complete sets for working on a workbench

**AG-3 DAD 16 K** Dental Exercise Unit complete with:  
dental model AG-3 DA  
hinged support D-16 K

Recommendation for usage: exercises without water, e.g. oral prophylaxis training on a workbench freely accessible from all sides.



**PK-1 PT** Dental Exercise Unit complete with:  
phantom head PK-1  
face mask P-6 GMN  
dental model AG-3 DA  
table mounting assembly P-TDG



**PK-2 PT** Dental Exercise Unit complete with:  
phantom head PK-2  
face mask P-6 GMN  
dental model AG-3  
table mounting assembly P-TDG



**P-6/3 PT** Dental Exercise Unit complete with:  
phantom head P-6/3  
face mask P-6 GMN  
dental model AG-3  
table mounting assembly P-TDGP



**P-6/3 PA** Dental Exercise Unit complete with:  
phantom head P-6/3  
face mask P-6 GMN  
dental model AG-3  
table mounting plate P-A



**Note: All Dental Exercise Units are also available with different dental models and different accessories (eyes, ears, water drainage systems etc.)**

# complete sets with small torso for working on a workbench

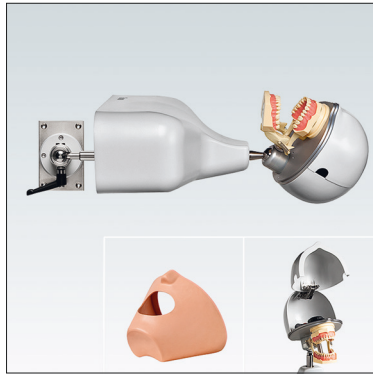

## PK-1 TKUTD

Dental Exercise Unit complete with:  
phantom head PK-1 HGB with limitation of head movement  
face mask P-6 GMN  
dental model AG-3 DA  
small shoulder torso P-TK 99-002  
mounting assembly P-UTD with plate and ball-joint  
for table-side fixation

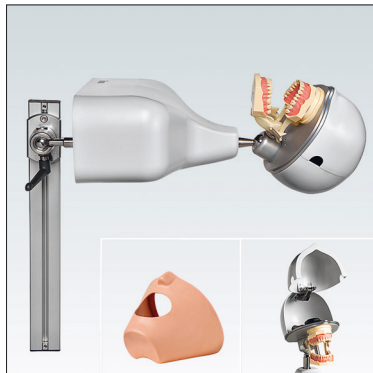

## PK-1 TKUTDS

Dental Exercise Unit complete with:  
phantom head PK-1 HGB with limitation of head movement  
face mask P-6 GMN  
dental model AG-3 DA  
small shoulder torso P-TK 99-002  
mounting assembly P-UTDS with guide rail and ball-joint  
for table-side fixation

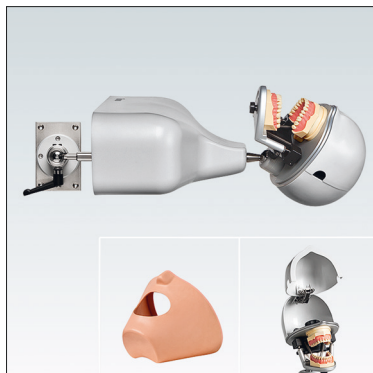

## PK-2 TKUTD

Dental Exercise Unit complete with:  
phantom head PK-2 HGB with limitation of head movement  
face mask P-6 GMN  
dental model AG-3  
small shoulder torso P-TK 99-002  
mounting assembly P-UTD with plate and ball-joint  
for table-side fixation



## PK-2 TKUTDS

Dental Exercise Unit complete with:  
phantom head PK-2 HGB with limitation of head movement  
face mask P-6 GMN  
dental model AG-3  
small shoulder torso P-TK 99-002  
mounting assembly P-UTDS with guide rail and ball-joint  
for table-side fixation

**Note: All Dental Exercise Units are also available with different dental models and different accessories (eyes, ears, water drainage systems etc.)**

# complete sets with small torso for working on a workbench

## PK-1 TKL

Dental Exercise Unit complete with:  
phantom head PK-1 HGB with limitation of head movement  
face mask P-6 GMN  
dental model AG-3 DA  
small shoulder torso P-TKM  
mounting device Lift-O-Mat P-TL 400A for lateral undertable fixation

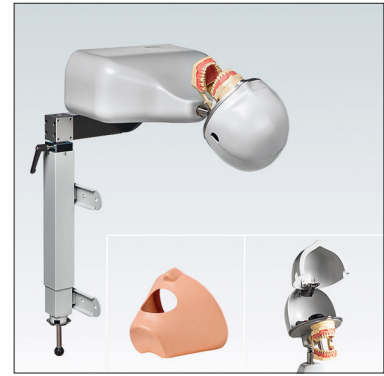

## PK-2 TKL

Dental Exercise Unit complete with:  
phantom head PK-2 HGB with limitation of head movement  
face mask P-6 GMN  
dental model AG-3  
small shoulder torso P-TKM  
mounting device Lift-O-Mat P-TL 400A for lateral undertable fixation



## P-6/3 TKL

Dental Exercise Unit complete with:  
phantom head P-6/3 HGB with limitation of head movement  
face mask P-6 GMN  
dental model AG-3  
small shoulder torso P-TKM  
mounting device Lift-O-Mat P-TL 400A for lateral undertable fixation



## P-6/5 TKL

Dental Exercise Unit complete with:  
phantom head P-6/5 HGB with limitation of head movement  
face mask P-6 GMN  
dental model AG-3  
small shoulder torso P-TKM  
mounting device Lift-O-Mat P-TL 400A for lateral undertable fixation



**Note: All Dental Exercise Units are also available with different dental models and different accessories (eyes, ears, water drainage systems etc.)**

# complete sets with shoulder torso for working on a workbench

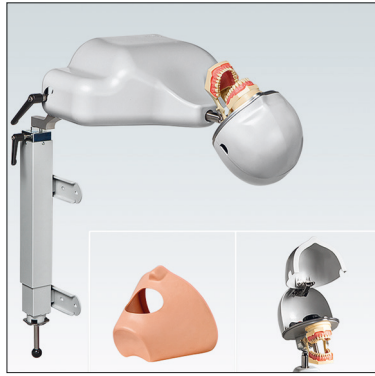

**PK-1 TL**

Dental Exercise Unit complete with:  
phantom head PK-1 HGB with limitation of head movement  
face mask P-6 GMN  
dental model AG-3 DA  
shoulder torso P-6 T  
mounting device Lift-O-Mat P-TL 400A for lateral undertable fixation



**PK-2 TL**

Dental Exercise Unit complete with:  
phantom head PK-2 HGB with limitation of head movement  
face mask P-6 GMN  
dental model AG-3  
shoulder torso P-6 T  
mounting device Lift-O-Mat P-TL 400A for lateral undertable fixation



**P-6/3 TL**

Dental Exercise Unit complete with:  
phantom head P-6/3 HGB with limitation of head movement  
face mask P-6 GMN  
dental model AG-3  
shoulder torso P-6 T  
mounting device Lift-O-Mat P-TL 400A for lateral undertable fixation

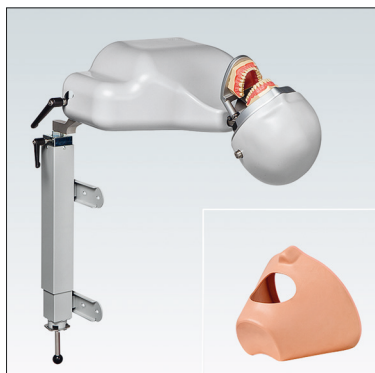

**P-6/5 TL**

Dental Exercise Unit complete with:  
phantom head P-6/5 HGB with limitation of head movement  
face mask P-6 GMN  
dental model AG-3  
shoulder torso P-6 T  
mounting device Lift-O-Mat P-TL 400A for lateral undertable fixation

**Note: All Dental Exercise Units are also available with different dental models and different accessories (eyes, ears, water drainage systems etc.)**



# dental training systems – table mounting

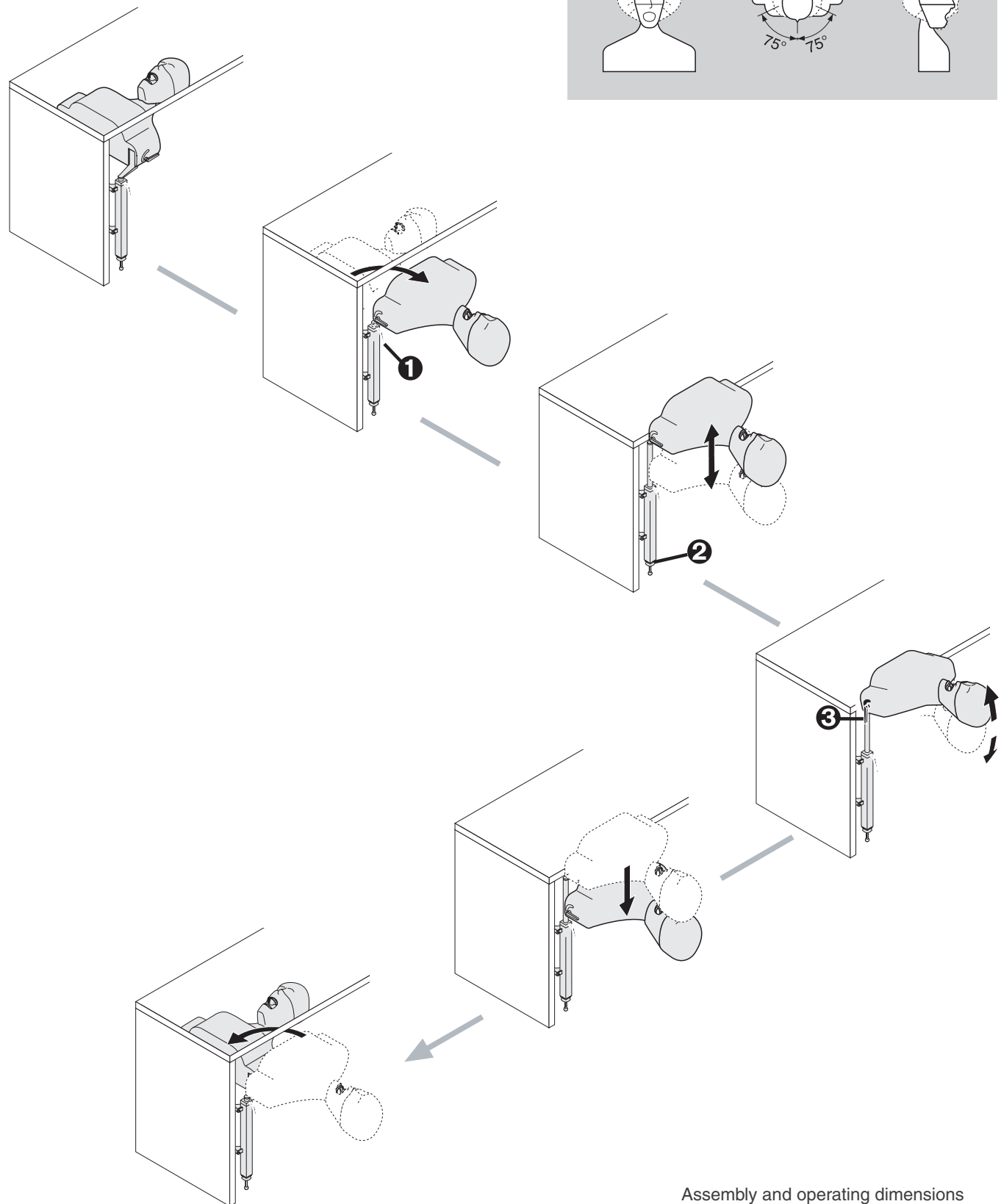

Assembly and operating dimensions  
upon request

# complete sets with shoulder torso for working on a dental chair



**PK-1 TSE**

Dental Exercise Unit complete with:  
phantom head PK-1 HGB with limitation of head movement  
face mask P-6 GMN  
dental model AG-3 DA  
shoulder torso P-6 TSE with belts for fixation on a dental chair



**PK-2 TSE**

Dental Exercise Unit complete with:  
phantom head PK-2 HGB with limitation of head movement  
face mask P-6 GMN  
dental model AG-3  
shoulder torso P-6 TSE with belts for fixation on a dental chair



**P-6/3 TSE**

Dental Exercise Unit complete with:  
phantom head P-6/3 HGB with limitation of head movement  
face mask P-6 GMN  
dental model AG-3  
shoulder torso P-6 TSE with belts for fixation on a dental chair



**P-6/5 TSE**

Dental Exercise Unit complete with:  
phantom head P-6/5 HGB with limitation of head movement  
face mask P-6 GMN  
dental model AG-3  
shoulder torso P-6 TSE with belts for fixation on a dental chair

**Note: All Dental Exercise Units are also available with different dental models and different accessories (eyes, ears, water drainage systems etc.)**

# dental training systems – dental chair fixation

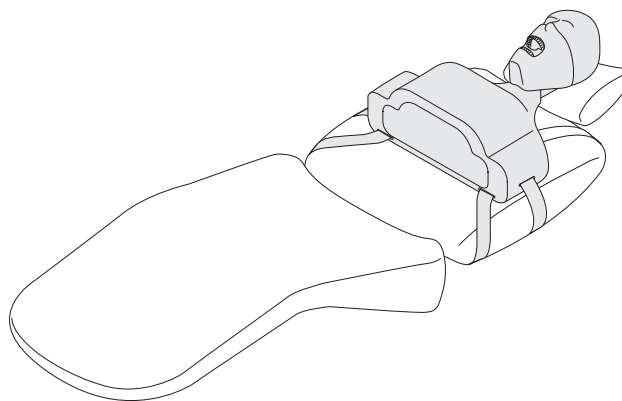
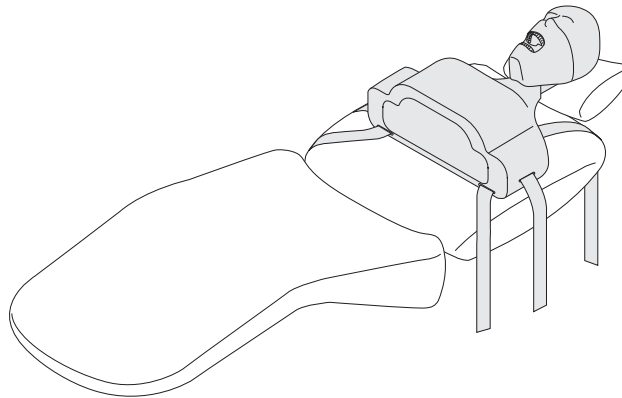
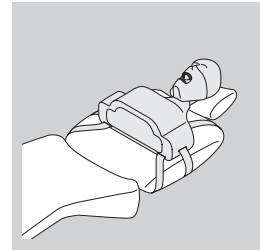
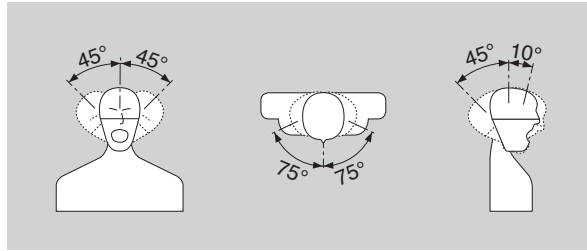

# dental training systems – dental chair fixation



## P-SH 9998-004

The P-SH 9998-004 chair mounting is used for fixing frasco phantom heads quickly and securely to head rests of dental units. If interested, we recommend requesting a drawing with the exact dimensions of the chair mounting. The dental unit must also allow clamping in the adjustment area of the head rest

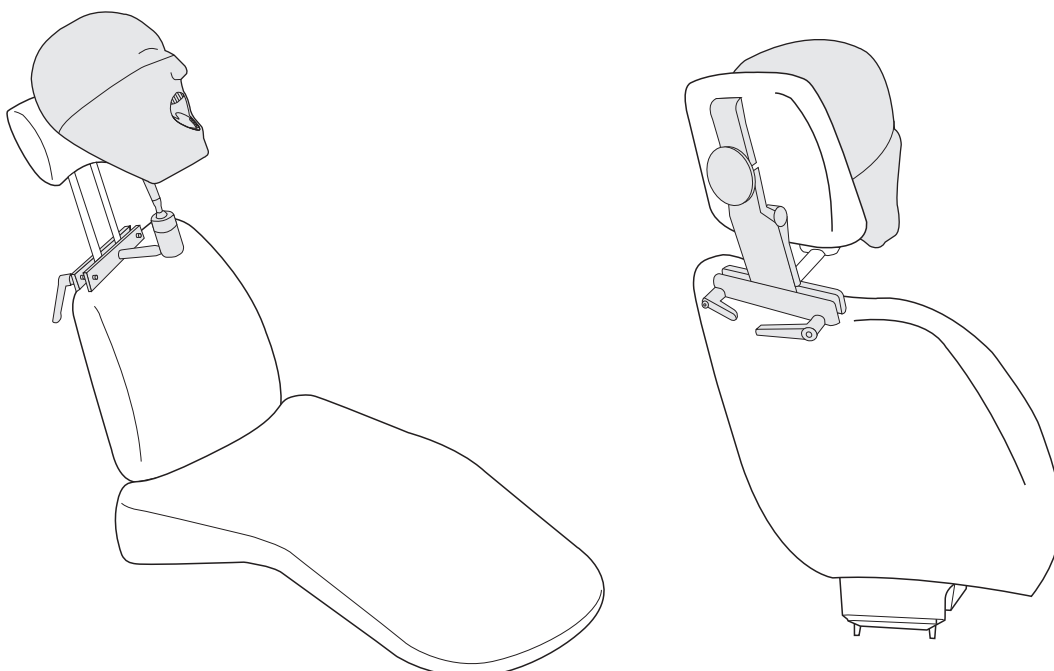
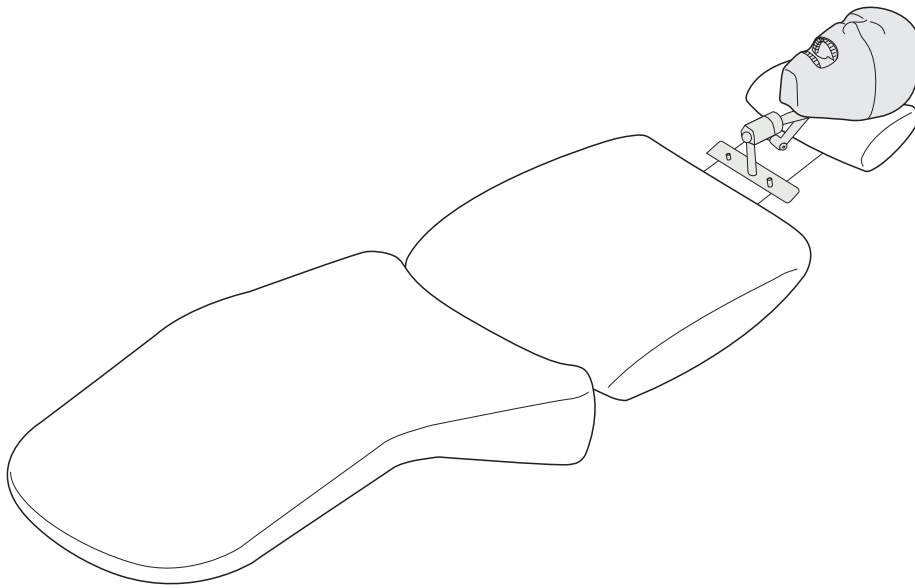

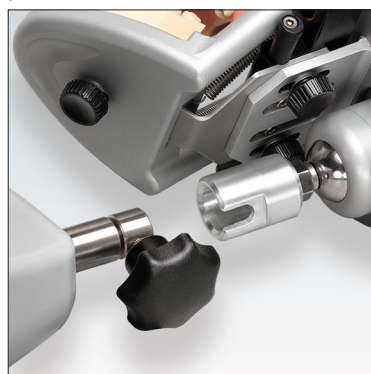
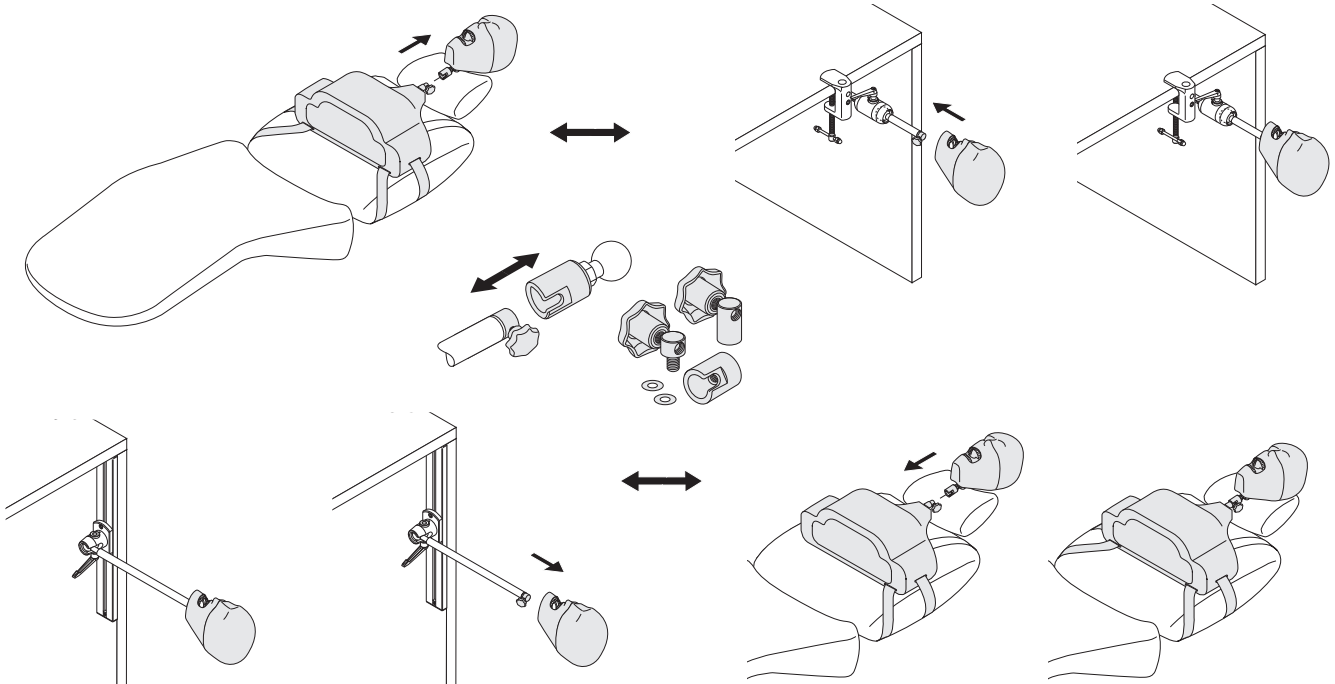

# mounting adaptor for quick interchange from shoulder torso to table fixation

**P-SKS** Mounting adaptor for frasaco dental training systems, can also be used for retrofitting existing configurations. With this interface a phantom head can be quickly and easily disassembled from table fixation on a workbench, reassembled on to a shoulder torso for dental chair practice, and then back again

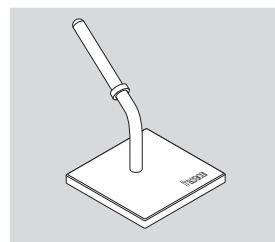
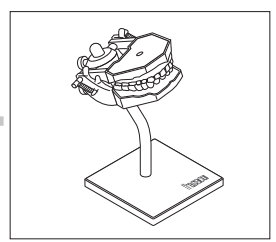
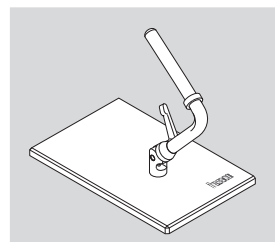
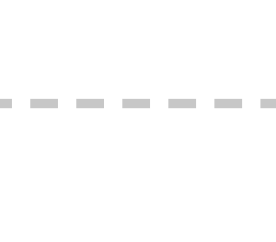
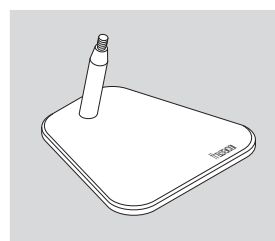
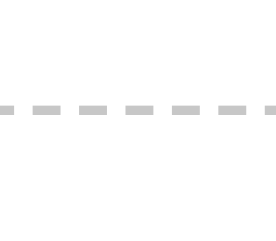
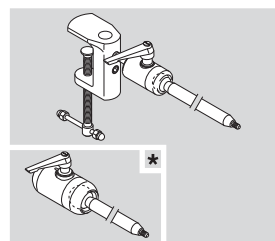

# mounting assemblies for dental models and phantom heads

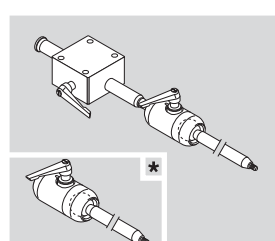
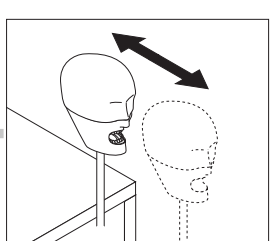
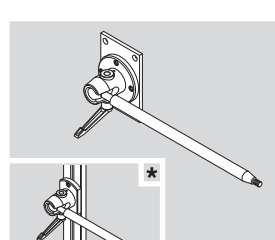
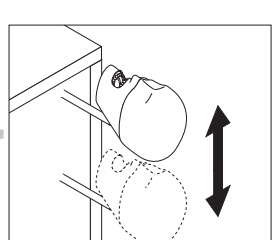
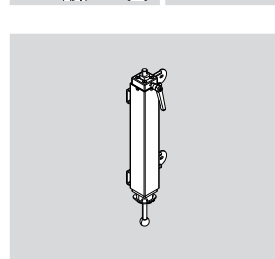
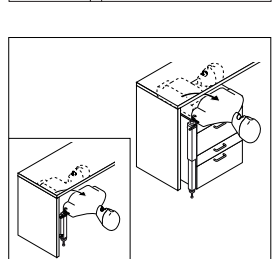
	part no.:	description / recommended use:	application:
	D-16	model support for demonstration purposes. Recommended for all dental models with demonstration articulators	
	D-16 K	hinged support for training upper jaw and lower jaw treatment positions. Recommended for all dental models with demonstration articulators	
	P-A	table mounting plate for demonstration of phantom heads. Recommended for phantom heads P-6/3, P-6/5, PK-1 and PK-2	
	P-TDG P-TDGP*	table mounting assembly with clamp, double balljoint and guidance rod for fixation of phantom heads P-6/5*, P-6/3*, PK-1 and PK-2	
	P-UTDG P-UTDGP*	mounting assembly with aluminium block to be fixed underneath bench-top. Extensible rod can be fixed at required length. Double ball-joint and guidance rod for swivel mounting of phantom heads P-6/3*, P-6/5*, PK-1 and PK-2	
	P-UTD P-UTDS*	mounting assembly with plate or aluminium guide rail* for fixation to the table side. Ball-and-socket joint and guidance rod for swivel mounting of phantom heads P-6/3, P-6/5, PK-1 and PK-2 or P-6/3 HGB, P-6/5 HGB, PK-1 HGB and PK-2 HGB with shoulder torso	
	P-TL 400A	Lift-o-Mat mounting for fixation to the table side. Guidance rod can be extended, adjusted in height, rotated and fixed in all required treatment positions. Also available in a special 180 hinged version (price on request). Recommended for phantom heads P-6/3 HGB, P-6/5 HGB, PK-1 HGB and PK-2 HGB with shoulder torso	



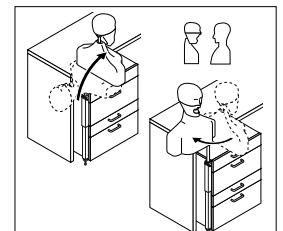
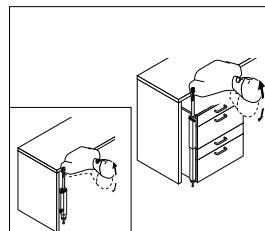
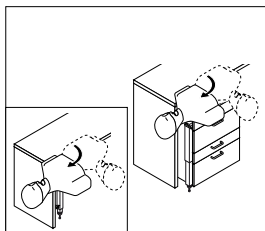
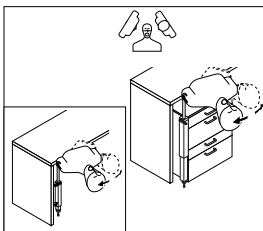
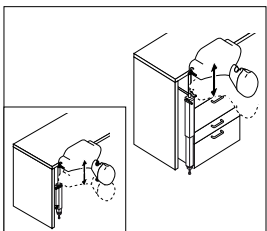
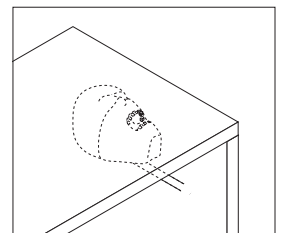
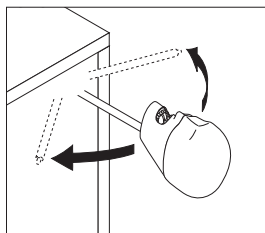
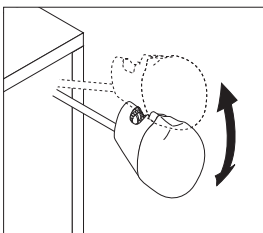
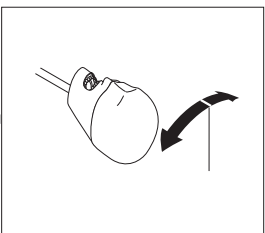
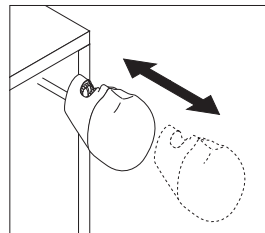
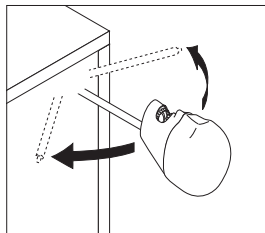
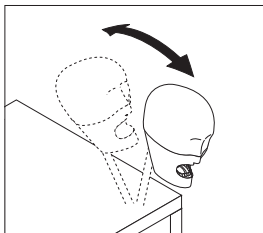
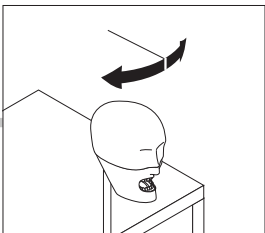
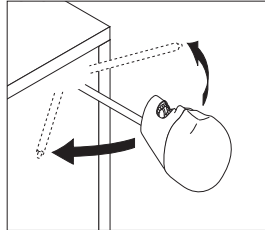
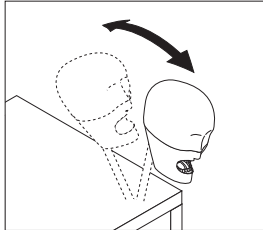
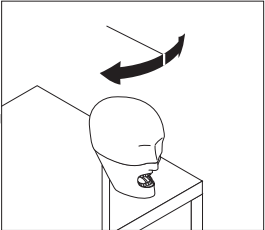
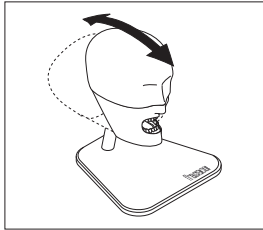
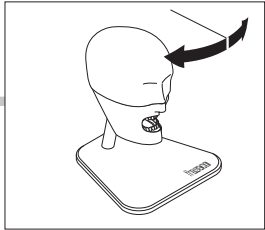
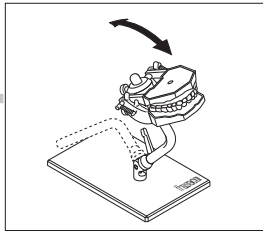

# dental training systems – complete workstations

As a system partner of companies specialized in the complete equipment of phantom laboratories, frasaco is offering customized modular solutions for dental training systems. We would be pleased to help you to contact the manufacturers of simulation workstations, as shown here

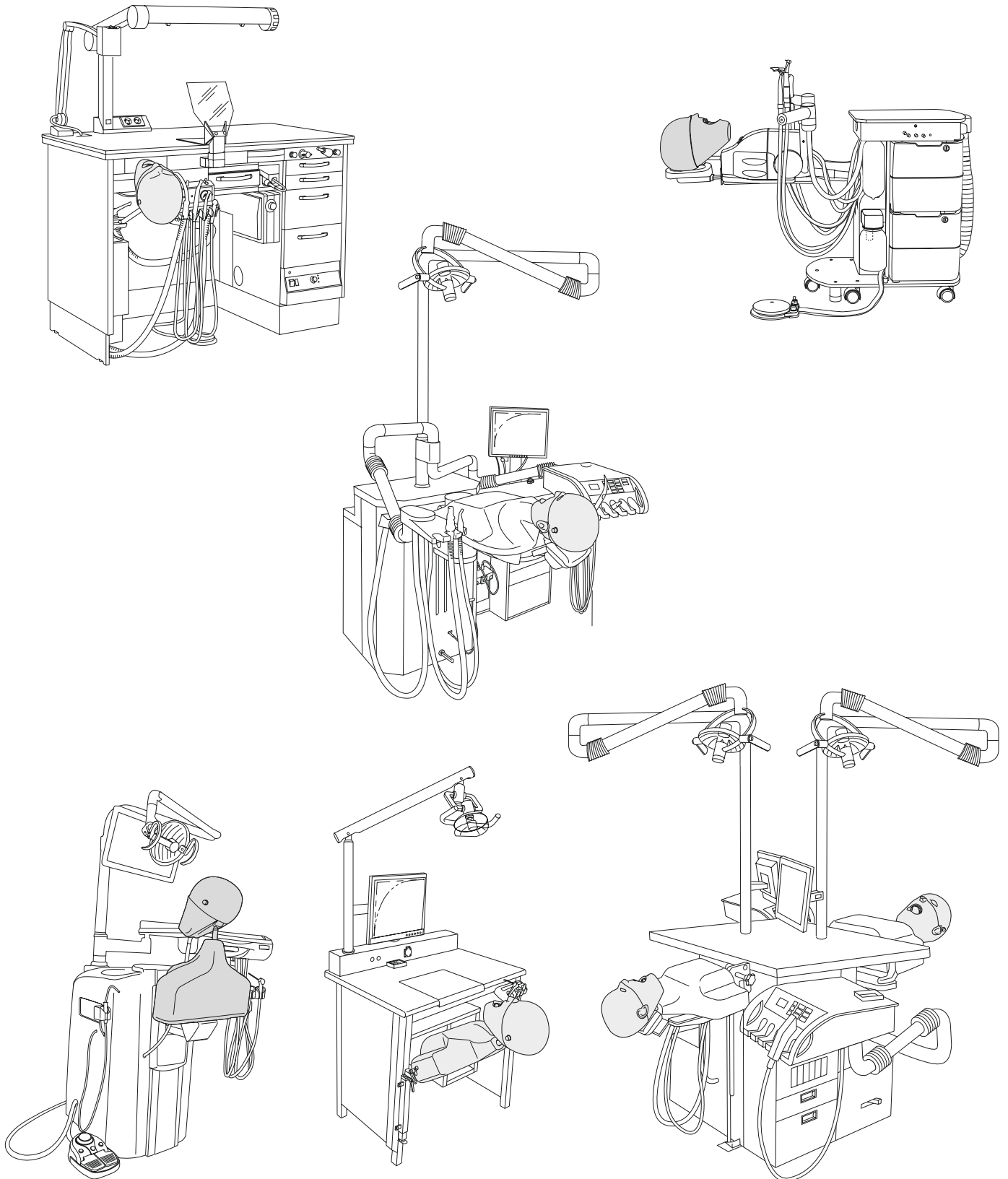

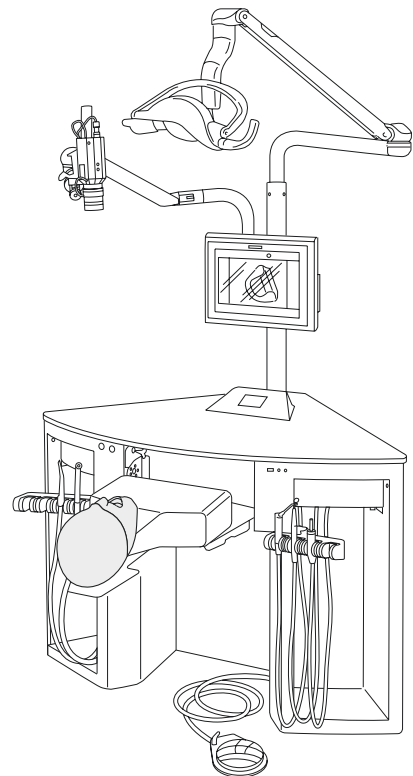
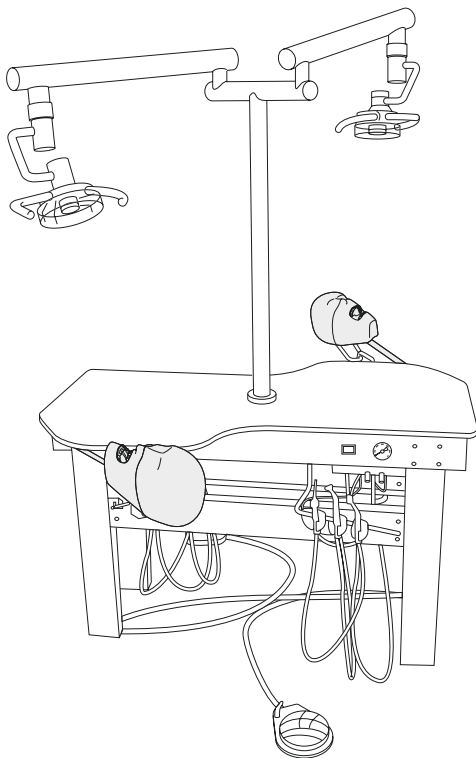
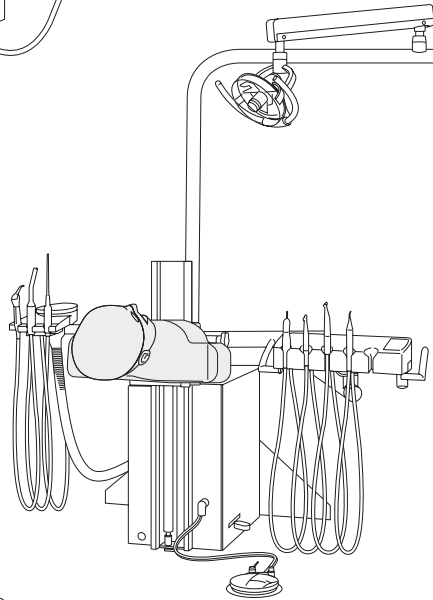
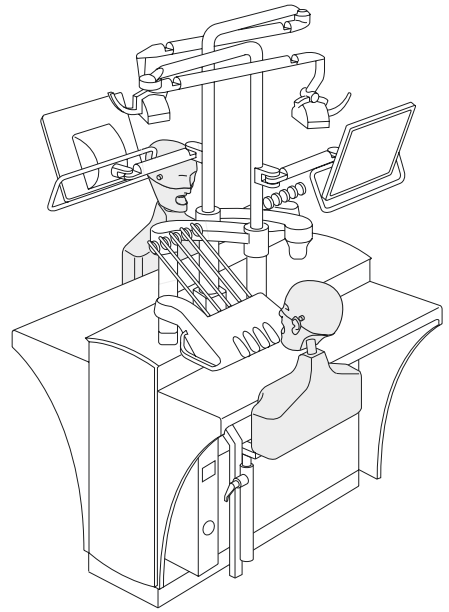
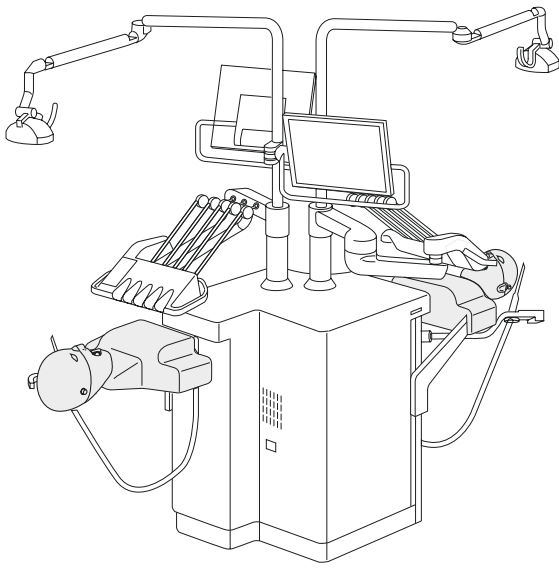



## sundries

### frasaco – crowns and more

#### frasaco strip crowns:

- renowned moulds for fast and clean temporary restorations
- elastic, thin and easy to cut, packed antistatically
- pedodontal strip crown available for restoration of badly damaged deciduous teeth
- wide range covering all required sizes
- assortments for proper storage and choice, refill-packages available

#### frasaco patented dispensers:

- quick and simple single-handed operation
- band exactly in the required length with neat and even cuts
- economical use and reduced waste
- one time purchase of the dispenser, cost-saving refill rolls available



frasaco strip crowns,  
matrix strips and matrix  
bands are medical devices  
and therefore intended  
for unique use only

# strip crowns

Save time and money with frasco strip crowns, achieving optimum efficiency in no time. Even for multiple layer technique, strip crowns can be used as matrix to shape the final layer.

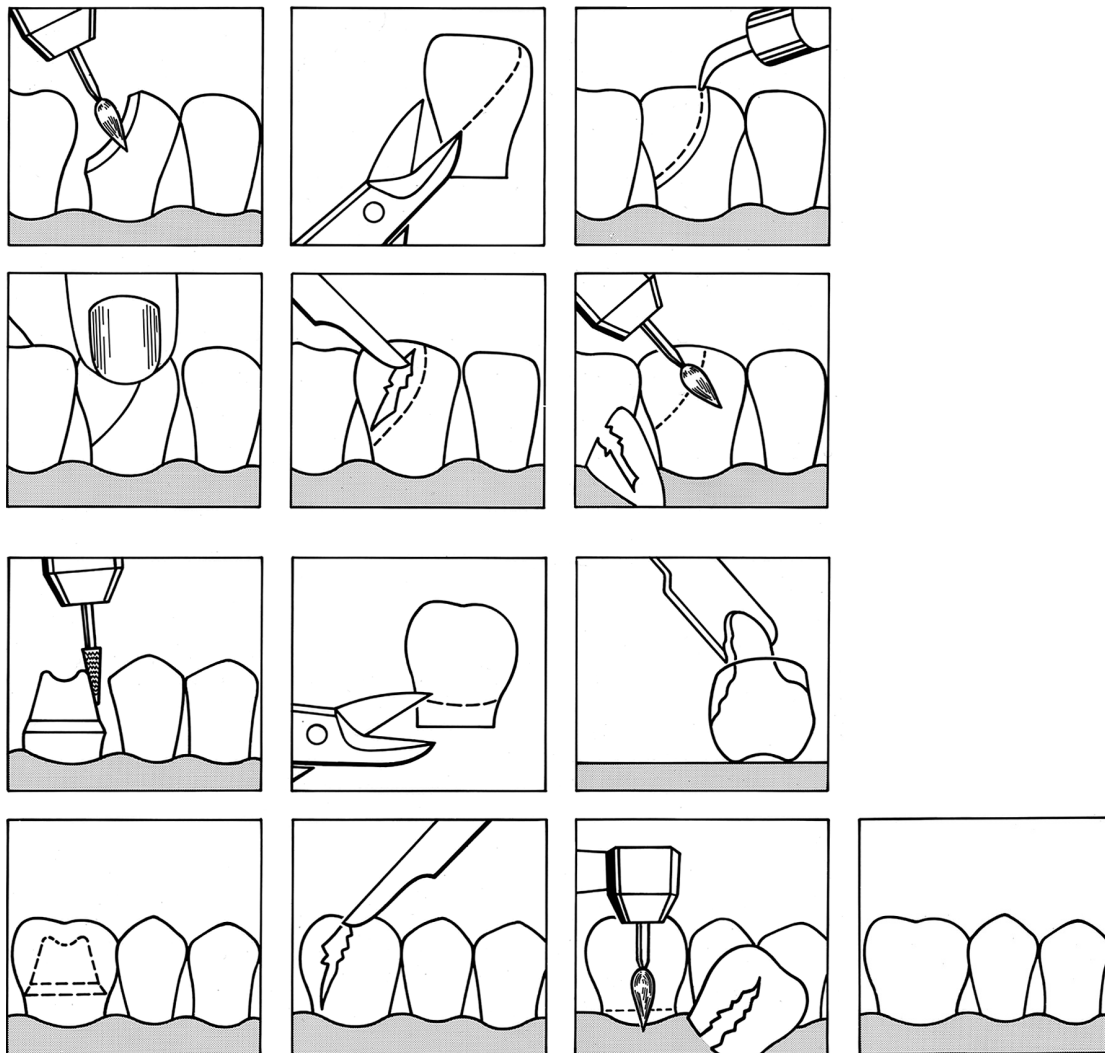

frasco strip crowns are elastic, thin and easy to cut celluloid crowns. In the transparent execution they are light-transmissive for polymerization light. They are used as moulds for creating temporary restorations on preparations and as matrices for restoration of corners and edges. They are placed without problem using any conventional material for temporary restorations. A strip crown in the required size and shape is adjusted to the cervical area and the gingival margin with a crown scissors. Prior to placement, ensure that strip crown and preparation are clean and dry. Fill the strip crown with temporary filling material and place it. Strip crowns can be used as matrices when restoring corners and edges – also when using composites. When doing so, cut out that section of the strip crown corresponding to the part of the tooth being restored, allowing for the strip crown to overlap the margins of the cavity. Fill the matrix with the definite filling material and press it into place. Remove the matrix after the filling material has set. Should strip crowns remain on a tooth for a few days, please make sure that their gingival edge is no deeper than 1 mm inside the sulcus to avoid possible traumatization of the marginal periodontium. Under no circumstances should strip crowns remain in the mouth for longer than 30 days.

# strip crowns – forms and sizes

**central incisor  
– upper right**



**lateral incisor  
– upper right**

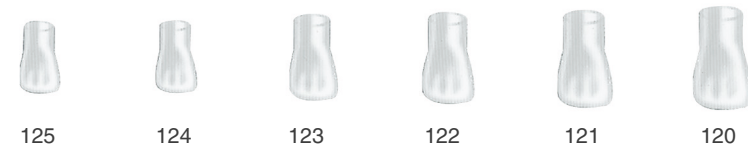

**canine  
– upper right**



**first premolar  
– upper right**



**first molar  
– upper right**

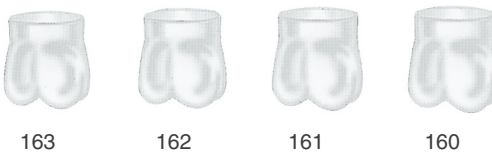

**Explanation of the description of frasco strip crowns:  
1st digit = quadrant | 2nd digit = position of the tooth | 3rd digit = size backward-sorted**

**first molar  
– lower right**

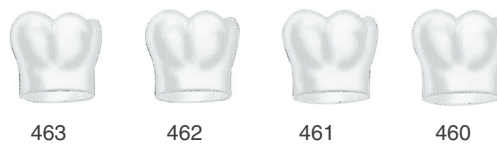

**first premolar  
– lower right**



**canine  
– lower right**



**lateral incisor  
– lower right**



**central incisor  
– lower right**







**central incisor  
upper left –**

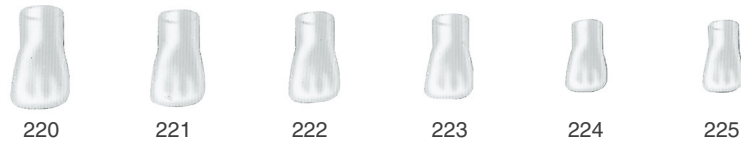

**lateral incisor  
upper left –**



**canine  
upper left –**



**first premolar  
upper left –**

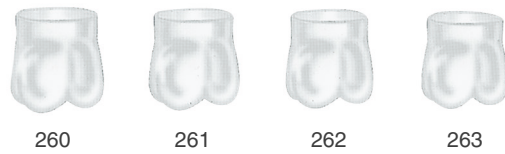

**first molar  
upper left –**

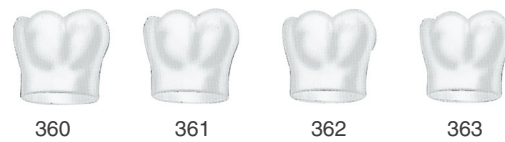

**first molar  
lower left –**



**first premolar  
lower left –**



**canine  
lower left –**



**lateral incisor  
lower left –**



**central incisor  
lower left –**

# transparent strip crowns



## ST-5K

5 transparent strip crowns of the same size  
refill package

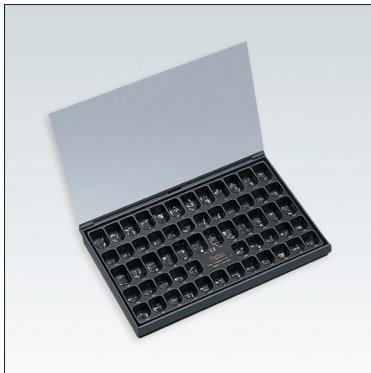

## ST-FK174

anterior assortment with  
174 transparent strip crowns  
plastic box with transparent cover  
3 strip crowns of the same size in 58 compartments

upper jaw	110 – 115, 120 – 125, 130 – 135
upper jaw	210 – 215, 220 – 225, 230 – 235
lower jaw	411 – 413, 420 – 422, 430 – 434
lower jaw	311 – 313, 320 – 322, 330 – 334



## ST-BK108

posterior assortment with  
108 transparent strip crowns  
plastic box with transparent cover  
3 strip crowns of the same size in 36 compartments

upper jaw	140 – 144, 160 – 163
upper jaw	240 – 244, 260 – 263
lower jaw	440 – 444, 460 – 463
lower jaw	340 – 344, 360 – 363

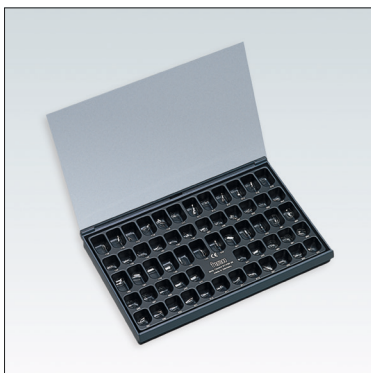

## ST-FBK 58

compact assortment (current anteriors and posteriors) with  
58 transparent strip crowns  
plastic box with transparent cover  
1 strip crown of one size in 58 compartments

upper jaw	111 – 116, 120 – 124, 131, 133, 141 – 143, 161, 162
upper jaw	211 – 216, 220 – 225, 231, 233, 241 – 243, 261, 262
lower jaw	311, 312, 321, 322, 330, 331, 341, 342, 360 – 362
lower jaw	411, 412, 421, 422, 430, 431, 441, 442, 460 – 462



## SL-2

arrangement system with 8 drawers for neat storage of frasco  
strip crowns in refill packages of 5 each, flexibly adaptable to specific  
requirements

**Note: no strip crowns included**

# coloured strip crowns

**ST-5E** 5 coloured strip crowns of the same size  
refill package



**ST-FE174** anterior assortment with  
174 coloured strip crowns  
plastic box with transparent cover  
3 strip crowns of the same size in 58 compartments

upper jaw	110 – 115, 120 – 125, 130 – 135
upper jaw	210 – 215, 220 – 225, 230 – 235
lower jaw	411 – 413, 420 – 422, 430 – 434
lower jaw	311 – 313, 320 – 322, 330 – 334



**ST-BE108** posterior assortment with  
108 coloured strip crowns  
plastic box with transparent cover  
3 strip crowns of the same size in 36 compartments

upper jaw	140 – 144, 160 – 163
upper jaw	240 – 244, 260 – 263
lower jaw	440 – 444, 460 – 463
lower jaw	340 – 344, 360 – 363



**ST-FBE 58** compact assortment (current anteriors and posteriors) with  
58 coloured strip crowns  
plastic box with transparent cover  
1 strip crown of one size in 58 compartments

upper jaw	111 – 116, 120 – 124, 131, 133, 141 – 143, 161, 162
upper jaw	211 – 216, 221 – 225, 231, 233, 241 – 243, 261, 262
lower jaw	311, 312, 321, 322, 330, 331, 341, 342, 360 – 362
lower jaw	411, 412, 421, 422, 430, 431, 441, 442, 460 – 462



**SL-2** arrangement system with 8 drawers for neat storage of frasaco  
strip crowns in refill packages of 5 each, flexibly adaptable to specific  
requirements

**Note: no strip crowns included**



# pedodontal strip crowns

Placing prefabricated Frasco pedodontal strip crowns is an excellent technique for retaining badly damaged deciduous teeth.

Formerly, deciduous teeth with carious defects were extracted once these exceeded a certain stage. Nowadays, they are left in the mouth as a spacer as it is known that the deciduous teeth are important for the unimpeded development of children's jaws. The progress made in conservative dentistry has changed the way in which this field is approached. Reference should also be made to aesthetic and phonetic aspects.

We have kept pace with these changes by supplying our pedodontal strip crowns in several sizes.

Allergies, which can be caused by other crown materials, are virtually eliminated.

## central incisor

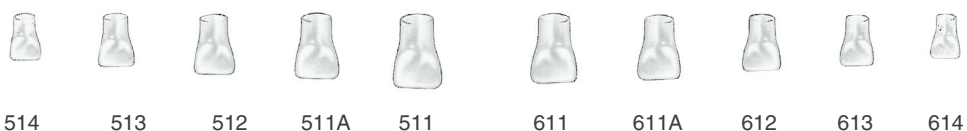

## lateral incisor

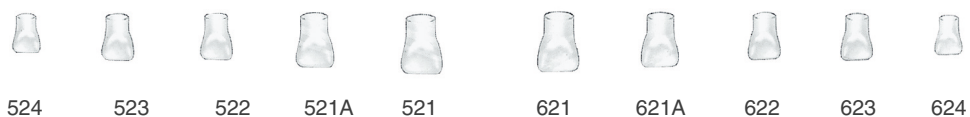

## canine

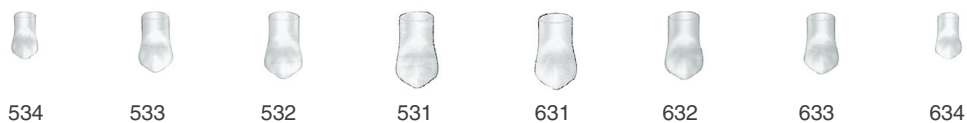

### ST-K5K

5 transparent strip crowns of the same size, refill package



### ST-KK84

pedodontal strip crown assortment with  
84 transparent strip crowns for upper anteriors  
plastic box with transparent cover  
3 strip crowns of the same size in 28 compartments

upper jaw	511 - 514
upper jaw	521 - 524
upper jaw	531 - 534
upper jaw	611 - 614
upper jaw	621 - 624
upper jaw	631 - 634

# matrix strips and dispensers

Tear resistant, plastic universal strips for use with auto-curing and light-curing composites and cements.  
To be used when shaping the restorations for class II, III, IV and V cavities

- Transparent and yellowish-transparent (not recommended for light polymerization of composites)
- Extra thin or standard thickness (retains its stability when being used for larger cavities)
- The yellowish-transparent band can easier be seen on the tooth or cabinet top

**Note: the part of the transparent matrix strips with the colour mark must not enter the mouth of the patient.**

Enjoy the one time purchase of the patented matrix band dispenser, refill rolls are available at an attractive price

universal strips, straight, length: 120 mm, width: 8.5 mm, package containing 50 pieces

- |                 |  |
|-----------------|--|
| <b>US-120KE</b> | transparent<br>extra thin: 0.05 mm           |
| <b>US-120KN</b> | transparent<br>standard thickness: 0.08 mm   |
| <b>US-120EE</b> | yellowish-transparent<br>extra thin: 0.05 mm |



universal strips, curved, length: 75 mm, width: 8.5 mm, package containing 50 pieces

- |                |  |
|----------------|--|
| <b>US-75KE</b> | transparent<br>extra thin: 0.05 mm           |
| <b>US-75KN</b> | transparent<br>standard thickness: 0.08 mm   |
| <b>US-75EE</b> | yellowish-transparent<br>extra thin: 0.05 mm |



matrix band dispenser incl. matrix band roll, length: 15 m, width: 8.5 mm

- |                 |  |
|-----------------|--|
| <b>US-15PKE</b> | transparent<br>extra thin: 0.05 mm           |
| <b>US-15PKN</b> | transparent<br>standard thickness: 0.08 mm   |
| <b>US-15PEE</b> | yellowish-transparent<br>extra thin: 0.05 mm |



matrix band refill roll, length: 15 m, width: 8.5 mm, package containing 3 rolls

- |                    |  |
|--------------------|--|
| <b>US-15PKEN</b>   | transparent, extra thin: 0.05 mm                                       |
| <b>US-15PKNN</b>   | transparent, standard thickness: 0.08 mm                               |
| <b>US-15PEEN</b>   | yellowish-transparent, extra thin: 0.05 mm                             |
| <b>US-15PKEN E</b> | package with 1 refill roll, transparent, extra thin: 0.05 mm           |
| <b>US-15PKNN E</b> | package with 1 refill roll, transparent, standard thickness: 0.08 mm   |
| <b>US-15PEEN E</b> | package with 1 refill roll, yellowish-transparent, extra thin: 0.05 mm |





# Certificate

The SKZ-Cert GmbH Zertifizierungen certifies to the company

**frasaco** GmbH  
Oberhoferstraße 18  
88069 Tett nang

the introduction and application of a quality management system according to  
**ISO 9001:2015**

Scope:  
**Development, production and distribution of dental and orthopaedic products,  
production of industrial plastic parts (injection moulded), mould manufacture**

The proof has been furnished by a quality audit.

This certificate is valid from: **16.02.2019** to: **15.02.2022**  
Certificate No.: **3565/18.R**

Würzburg, 18.01.2019

Certification Body







# CERTIFICATE



This is to certify that the company

## frasaco GmbH

Oberhofer Straße 18  
88069 Tett nang  
Germany

has implemented and maintains a **Quality Management System**.

**Scope:**

Development, production and distribution of dental and orthopedic products.

Through an audit, documented in a report, performed by DQS Medizinprodukte GmbH, it was verified that the management system fulfills the requirements of the following standard:

**DIN EN ISO 13485 : 2016 + AC : 2017-07**  
**EN ISO 13485 : 2016 + AC : 2016**  
**ISO 13485 : 2016**

Certificate registration no.	538204 MP2016
Certificate unique ID	170715448
Effective date	2019-02-03
Expiry date	2022-02-02
Frankfurt am Main	2019-02-03



## DQS Medizinprodukte GmbH

Sigrid Uhlemann  
Managing Director

Dr. Thomas Feldmann  
Head of Certification Body

August-Schanz-Straße 21, 60433 Frankfurt am Main,  
Tel. +49 (0) 69 95427-300, [medical.devices@dqs-med.de](mailto:medical.devices@dqs-med.de)



# general commercial conditions

for use in relation to companies, legal entities under public law or public funds

The following terms and conditions shall apply to all future deliveries, services and quotations in relation to the buyer, even if no express reference to these terms and conditions has been made. Any contrary terms and conditions of purchase of the buyer shall not apply, and shall be binding upon frasaco only if they have been expressly accepted by frasaco. Even if frasaco makes reference to any letter containing, or referring to, terms and conditions of the customer or any third party, this shall not constitute consent to the application of such terms and conditions. If any individual provisions are or become ineffective, the other terms and conditions shall not be affected hereby.

Insofar as the products marketed by frasaco are medical devices under Section 3 (1) Medizinproduktegesetz [Medical Devices Act], the buyer shall comply with all applicable statutory provisions and secondary provisions (statutory orders, directives) relating to the installation, operation and use of medical devices and relating to the recording, assessment and prevention of risks in respect of medical devices in circulation or operation.

## 1. Quotation and Conclusion of Contract

- a) Quotations shall be subject to change without notice, to availability and to prior sale.
- b) Orders shall become binding only upon frasaco's written acknowledgement of the order.
- c) Amendments and supplements to the agreement made, including these General Terms and Conditions of Business, shall only be effective in writing.

## 2. Prices

- a) The selling prices quoted in the respective latest version of the price list shall apply. Prices shall be subject to change without prior notice. However, a minimum order value of € 50.00 net shall be charged even if the purchase order is below this value
- b) Selling prices shall be in € net, ex works Tettngang and exclude packaging, insurance, freight charges, customs duty and incidental import levies. Value-added tax shall be added at the respective statutory rate, insofar as applicable.
- c) In addition to the aforementioned amounts, a handling fee of € 10.00 net shall be charged in the case of any order value below € 200.00 net. This handling fee shall not apply to order values above € 200.00 net.

## 3. Obligation to deliver/take delivery

- a) Periods and deadlines promised by frasaco in respect of delivery or performance shall always only be approximate, unless a fixed period or deadline has been expressly guaranteed or agreed upon. Compliance with such deadlines and periods shall always be conditional upon the timely receipt of all documents essential for carrying out the order, as well as any down payment agreed upon. Otherwise, the deadlines and periods for delivery or performance shall be appropriately extended. Section 10 shall apply as regards the provision of material by the buyer.

In cases where shipment has been agreed upon, the periods and deadlines shall relate to the time of hand-over to the forwarder, carrier or any other third party appointed to carry out transportation.

- b) If frasaco defaults on delivery or performance, or if for whatever reason it becomes impossible for frasaco to deliver or perform, frasaco's liability shall be limited to compensatory damages under the terms of Section 7.
- c) frasaco shall be entitled to make sub-deliveries, if such sub-delivery can be used by the buyer for the purpose intended under the contract, if it has been ensured that the residual goods ordered will be delivered, and if this does not involve any substantial extra work or cost for the buyer, unless frasaco agrees to assume such extra cost. Moreover, deviations of up to +/- 10 % from the quantities ordered shall be permissible.
- d) If the buyer fails to fulfil its obligation to take delivery despite a reminder, frasaco shall be entitled, without prejudice to its other rights, to sell the delivery item on the open market.
- e) Except where a special agreement has been made, shipments of samples shall be invoiced after 30 days, calculated from the date of the delivery note.
- f) Goods returned for reasons not imputable to frasaco shall be accepted only by prior arrangement and only if the goods are in faultless condition and in their original packaging, and if postage has been paid. frasaco hereby reserves the right to decide in any individual case whether to accept returned goods. There shall be no entitlement to return custommade goods or goods delivered more than 3 months previously. Section 6 shall remain unaffected by this provision.

Credit notes shall be issued only if the original invoice and the original delivery note have been enclosed with the goods returned. In the case of a credit note, a handling fee of € 50.00 net and an additional resorting fee of 20 % of the order value shall be charged.

- g) Any events of force majeure shall entitle frasaco to postpone delivery by the duration of the hindrance plus a reasonable start-up period, or to wholly or partly rescind the order on account of the part of the order not performed, provided that such disruptions are of temporary duration. Strike, lockout or unforeseeable circumstances, e.g. business disruptions, that make it impossible for frasaco to deliver on time despite reasonable efforts shall be deemed to be equivalent to force majeure. Insofar as any aforementioned events make it materially more difficult or impossible for frasaco to deliver or perform, and such hindrance is not of temporary duration, frasaco shall be entitled to rescind the contract. If, as a result of such delay, it would be unreasonable to expect the buyer to accept delivery or performance, the buyer may rescind the contract by written declaration to frasaco forthwith.

## 4. Packaging, Shipment, Passage of Risk

- a) frasaco shall choose the packaging, mode of shipment and method of shipment at its dutiful discretion and in accordance with any and all applicable legal provisions. Packaging material shall be charged at cost price.
- b) frasaco shall effect transportation insurance for all deliveries. In any event, insurance costs shall be borne by the buyer. If any damage occurs in transit, confirmation from the relevant post office or forwarder shall be sent to frasaco.
- c) Even in the case of delivery carriage paid, the risk shall pass to the buyer as soon as the goods leave the premises of frasaco's supplier. If dispatch is delayed through the fault of the buyer, the risk of accidental destruction shall already pass to the buyer upon notification of readiness for shipment.

## 5. Retention of Title

- a) The goods delivered (goods under retention of title) shall remain frasaco's property until all claims existing now or in future against the buyer have been satisfied. In the case of a running account, such retention of title shall be deemed to be security for the balance owed by the buyer. During the period of retention of title, the buyer shall not be entitled to pledge the goods or to assign the same to third parties as security.
- b) In case the goods are on-sold, the buyer hereby assigns to frasaco, until all frasaco's claims have been satisfied, the proceeds receivable from such on-selling, as well as any other claims that the buyer is entitled to against its customers as result of such on-selling (particularly tort claims and claims to insurance benefits). frasaco hereby accepts this assignment. At frasaco's request, the buyer shall provide frasaco with all information and documents necessary for asserting frasaco's rights against the buyer's customers. frasaco hereby revocably authorises the buyer to collect in the buyer's own name the claims assigned to the seller. frasaco shall revoke such authorisation to collect only in the event that the goods are realised as security.
- c) Any attachment or seizure of goods under retention of title by third parties shall be reported to frasaco forthwith. All intervention costs ensuing therefrom shall, in any event, be borne by the buyer.
- d) frasaco shall release goods under retention of title, if and insofar as their value exceeds by more than 20 % the sum of the claims secured. In this respect, frasaco shall be free to choose which goods to release.

## 6. Alterations, Liability for Defects

- a) frasaco hereby reserves the right to alter the design or manufacture of its products in keeping with technical progress, or to completely remove products from its product range, without prior notice. Information provided in prospectuses, advertising mail, advertisements or demonstration items shall not constitute agreed qualities. This shall apply also to illustrations, drawings and size- or weight-related data enclosed with quotations, unless these are expressly referred to as binding.
- b) Any agreement on certain features of the goods or on the production of moulds must be in writing. Any reference to technical standards shall serve as a performance specification.
- c) Any notification of obvious defects shall be made forthwith upon receipt of the delivery.
- d) If a quality-related defect exists, such defect shall be eliminated, or a replacement shall be provided free of charge, at frasaco's option. If such replacement or rectification fails twice, the buyer may assert the statutory warranty claims under these General Terms and Conditions of Business. Parts replaced shall be returned at frasaco's request. In any event, warranty claims shall become statute-barred one year after the buyer has received the goods.

## 7. General Limitations of Liability

- a) In cases where fault is relevant, frasaco's liability for compensatory damages on whatever legal basis, particularly on the basis of impossibility, default, defective or incorrect delivery, breach of contract, culpa in contrahendo and tort, shall be limited in accordance with this Section 7.
- b) frasaco shall not be liable in cases of ordinary negligence on the part of its organs, statutory representatives, employees or other authorised agents, except where duties material to the contract have been breached. Duties material to the contract are defined as duties that ensue from the nature of the contract and that, if breached, would jeopardise attainment of the purpose of the contract.
- c) Insofar as frasaco is liable in principle under Item 7 (b), such liability shall be limited to the loss that was, at the time of contract closure, foreseen by frasaco as being a possible consequence of any breach of contract, or that frasaco ought to have foreseen at such time by applying the diligence customary in the trade. Additionally, any collateral loss and consequential loss incurred as a result of defects in the item delivered shall be compensatable only insofar as such loss is to be typically expected when the item delivered is used as intended.
- d) In cases of liability for ordinary negligence, frasaco's obligation to compensate for property damage and any further pecuniary loss resulting therefrom shall be limited to an amount of € 5,000,000.00 per occurrence of damage or loss, even if duties material to the contract have been breached.
- e) The above exclusions and limitations of liability shall apply to the same extent in favour of frasaco's organs, statutory representatives, employees and other authorised agents.

f) The limitations under this Section 7 shall not apply to any liability of frasaco based on intentional misconduct, qualities guaranteed, mortal injury, physical harm or health damage or claims under the Produkthaftungsgesetz [Product Liability Act].

#### 8. Payment Terms

- a) All payments shall be made in € (euros) exclusively to frasaco. A cash discount shall be allowed only if all invoices due earlier have been settled.
- b) Invoices from frasaco shall be due and payable within 30 days of the invoice date, if nothing to the contrary has been agreed upon in writing, and the invoicee is based in the Federal Republic of Germany.
- c) If the invoicee is based outside of the Federal Republic of Germany, delivery shall be subject to advance payment, unless otherwise agreed upon in writing. Payments in foreign currency shall be credited at the respective current € exchange rate. In this respect, the buyer shall bear the exchange rate risk. Exchange rate differences, bank charges and the like shall be passed on to the buyer, and shall be settled forthwith.
- d) If the agreed payment deadline is exceeded, interest at the rate of 8 % above the respective valid base interest rate shall be charged per annum in accordance with Section 247 BGB [German Civil Code].
- e) frasaco hereby reserves the right to refuse to accept cheques and bills of exchange. Checks and rediscountable bills of exchange shall be accepted only on account of performance. All costs in connection therewith, particularly discounting charges, shall be borne by the buyer.
- f) The buyer shall not be entitled to set off against claims of frasaco or assert a right of retention, unless the buyer's claims are undisputed, have been determined by a final and non-appealable court judgement or are at the final judgement stage.
- g) Any culpable non-compliance with payment terms, such as default in payment for example, or any circumstances giving rise to serious doubts about the buyer's credit-worthiness, shall cause all frasaco's claims to fall due immediately.

#### 9. Moulds and Tools

- a) The price for moulds shall also include the costs for one single supply of samples, not however the costs for testing and machining devices, nor for alterations requested by the buyer. Costs for any further supply of samples that are imputable to frasaco shall be borne by frasaco.
- b) frasaco is and shall remain the owner of all moulds made for the buyer by frasaco itself or by any third party contracted by frasaco. As long as the buyer meets its obligations to pay and take delivery, moulds shall be used only for orders placed by the buyer. frasaco shall be obliged to replace such moulds free of charge only if such moulds are essential for fulfilling an output quantity guaranteed to the buyer. frasaco's obligation to retain such moulds shall lapse two years after the last delivery of parts made out of such mould, and after prior notification of the buyer.
- c) If it is agreed that the buyer shall become the owner of such moulds, title shall pass to the buyer upon payment of the purchase price for the moulds. Instead of handing over the moulds to the buyer, frasaco shall be under an obligation to retain the moulds. frasaco shall mark the moulds as externally owned property, and shall, at the buyer's request, insure such moulds at the buyer's expense.
- d) In the case of moulds owned by the buyer and/or made available by the buyer on loan, frasaco's liability as regards retention and care shall be limited to the level of diligence that it applies in its own affairs. Costs for servicing and insurance shall be borne by the buyer. frasaco's obligations shall lapse, if the moulds have not been collected by the buyer within a reasonable period after completion of the order and a corresponding request to the buyer. As long as the buyer has not fully met its contractual obligations, frasaco shall, in any event, be entitled to retain the moulds.

#### 10. Material Provided by the Buyer

- a) If material is to be provided by the buyer, such material shall, at the buyer's own expense and risk, be supplied to frasaco in due time and faultless condition with an appropriate quantity surplus of at least 5 %.
- b) If these prerequisites are not met, or not met in due time, the delivery period shall be reasonably extended. Except in cases of force majeure under Item 3 (g), the buyer shall bear all resulting extra costs, including costs in connection with interruptions in manufacture.
- c) frasaco shall assume no responsibility for the quality or composition of material provided by the customer. The customer shall be solely responsible for ensuring that the raw materials provided are absolutely suitable for production, and that they satisfy the statutory provisions. frasaco shall not carry out any examination or analysis of the material provided by the customer, unless this has been expressly agreed upon in writing.

#### 11. Property Rights

- a) If frasaco is required to deliver on the basis of drawings, models or samples, or using parts provided by the buyer, the buyer shall be accountable that no third-party property rights are infringed as a result thereof. frasaco shall point out to the buyer all such rights known to it. The buyer shall indemnify frasaco against all third-party claims, and shall compensate for any loss incurred. frasaco shall be entitled, without this requiring any examination of the legal position, to temporarily discontinue work, if a third party pleading a property right belonging to it prohibits frasaco from manufacturing or delivering.

- b) All drawings and samples sent to frasaco for the purpose of submission of a quotation shall be returned to the buyer at the buyer's request, or shall otherwise be destroyed three months after the submission of a quotation, if the buyer has not accepted the quotation in due time.
- c) frasaco shall be entitled to copyrights and any industrial property rights in the models, moulds, devices, drafts and drawings made by frasaco or by third parties on its behalf.

#### 12. Principle of Separability

If the buyer is a medical institution or a member of a healthcare profession, frasaco and the buyer hereby affirm that the decision to purchase is based solely on quality and price. The procurement and the marketing of the goods by frasaco shall be subject to general competition in terms of price and performance. The buyer hereby affirms that no other considerations have been relevant, and that there are no other reasons for its decision to purchase (e.g. gratuities to the buyer).

#### 13. Place of Performance, Place of Jurisdiction and Applicable Law

- a) For both Parties hereto, Tettng shall be the place of performance for delivery and payment. Tettng shall be the place of jurisdiction for both Parties hereto. However, frasaco hereby reserves the right to bring an action before the court having jurisdiction over the buyer's registered office, where necessary.
- b) The laws of the Federal Republic of Germany shall exclusively apply.



Telephone / Export Dept.

+49(0)7542/9315-23

Telefax

+49(0)7542/9315-15

frasaco GmbH

P.O. Box 1244, D-88061 Tett nang  
Germany

[info@frasaco.de](mailto:info@frasaco.de)

[www.frasaco.de](http://www.frasaco.de)

